

WAGNER® The Painting People™

2-STEP PRO DUTY POWER PAINTER™

OWNER'S MANUAL • Read this manual for complete instructions

MANUEL DE L'UTILISATEUR • Lire ce manuel contient les instructions complètes

MANUAL DEL PROPIETARIO • Lea este manual para obtener instrucciones completas

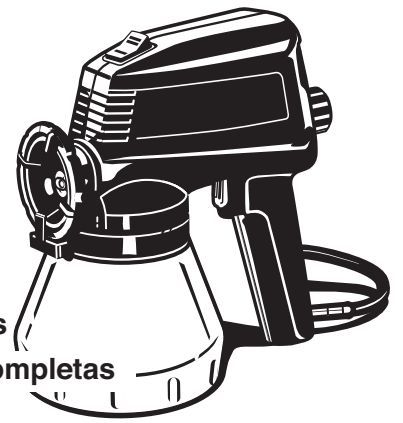

SETUP/USE • MONTAGE/UTILISATION • DISPOSICIÓN/USO :



1

Read all warnings!
Lire toutes les MISES EN GARDE!
¡Lea todas las ADVERTENCIAS!

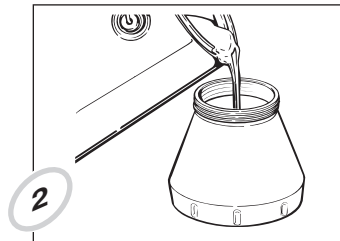

2

Fill the container
Remplir le contenant
Llene el envase

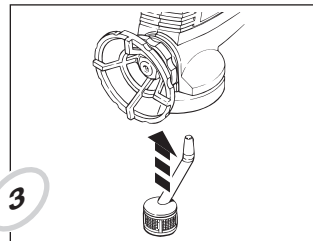

3

Attach the suction set
Fixer le dispositif d'aspiration
Conecte la unidad de succión

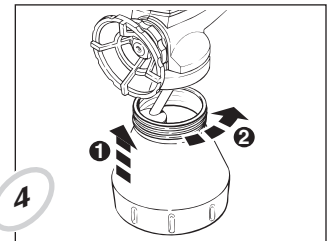

4

Screw on the container
Visser sur le contenant
Enrosque el envase

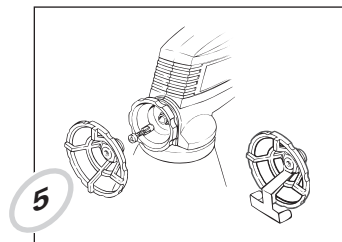

5

Select the spray tip
Sélectionner l'embout
Selecione la boquilla

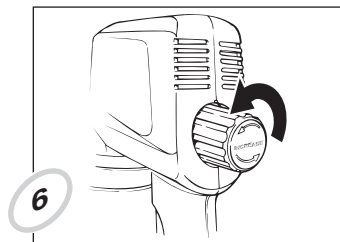

6

Set flow to maximum
Régler le débit au maximum
Ajuste la salida al nivel máximo

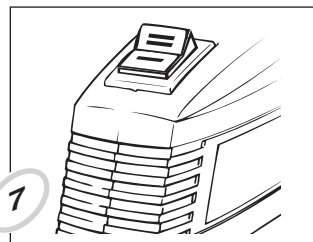

7

Plug in, set power level
Brancher, régler la puissance
Enchufe, ajuste el nivel de potencia

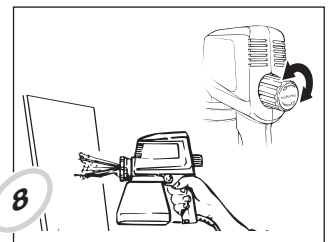

8

Test and adjust spray pattern
Vérifier et régler la forme du jet
Pruebe y ajuste el patrón de rociado

CLEANUP • NETTOYAGE • LIMPIEZA :

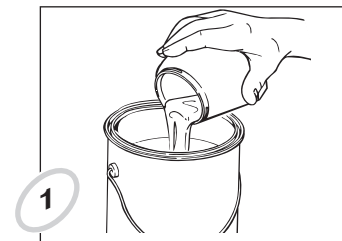

1

Return excess paint to can
Remettre le produit restant dans le pot
Regrese el exceso de pintura a la lata

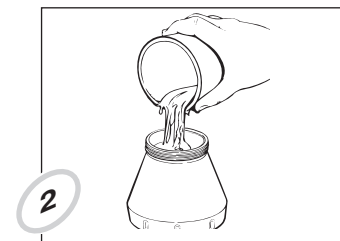

2

Fill with appropriate cleaning solution
Remplir de la solution de nettoyage appropriée
Llene el envase con la solución de limpieza apropiada

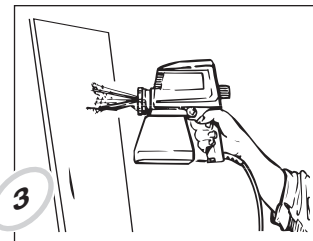

3

Spray solution for several seconds
Pulvériser la solution pendant plusieurs secondes
Rocíe la solución durante varios segundos

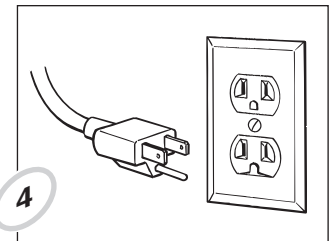

4

Unplug the sprayer
Débrancher le pulvériser
Desenchufe la pistola

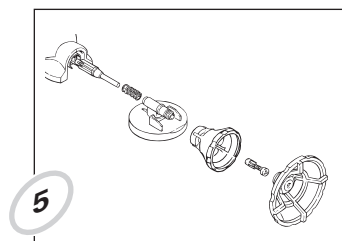

5

Remove pump components
Retirer les composants de la pompe
Desarme las piezas de la bomba

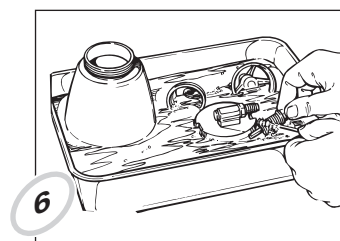

6

Clean components
Nettoyer les composants
Limpie el las piezas

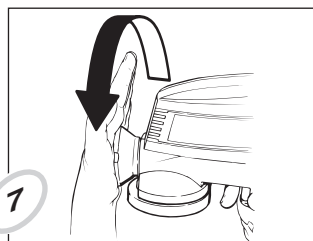

7

Reassemble
Remonter
Vuelva a armar a bomba

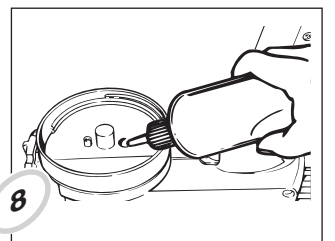

8

Lubricate
Lubrifier
Lubrique

SAFETY

⚠ WARNING

HAZARD: INJECTION INJURY - A high pressure stream of paint produced by this equipment can pierce the skin and underlying tissues, leading to serious injury and possible amputation.

DO NOT TREAT AN INJECTION INJURY AS A SIMPLE CUT! Injection can lead to amputation. See a physician immediately.

NOTE TO PHYSICIAN:

Injection into the skin is a traumatic injury. It is important to treat the injury surgically as soon as possible. **DO NOT** delay treatment to research toxicity. Toxicity is a concern with some coatings injected directly into the blood stream. Consultation with a plastic surgeon or reconstructive hand surgeon may be advisable.

PREVENTION:

- NEVER aim the gun at any part of the body.
- NEVER allow any part of the body to come in contact with the fluid stream.
- NEVER put your hand in front of the gun. Gloves will not provide protection against an injection injury.
- Always unplug the spray gun before servicing, cleaning tip guard, changing tips, or leaving unattended.
- ALWAYS have the tip guard in place while spraying. The tip guard provides some protection against injection injuries but is mainly a warning device.

HAZARD: EXPLOSION OR FIRE - Solvent and paint fumes can explode or ignite, causing property damage and/or severe injury.

PREVENTION:

- Exhaust and fresh air introduction must be provided to keep the air within the spray area free from accumulation of flammable vapors.
- Avoid all ignition sources such as static electricity sparks, open flames, pilot lights, hot objects, cigarettes, and sparks from connecting and disconnecting power cords or working light switches.
- Fire extinguishing equipment must be present and in good working order.
- Follow the material and solvent manufacturer's safety precautions and warnings.

HAZARD: EXPLOSION DUE TO INCOMPATIBLE MATERIALS - May cause property damage or severe injury.

PREVENTION:

- Do not use bleach.
- Do not use halogenated hydrocarbon solvents such as methylene chloride and 1,1,1 - trichloroethane. They are not compatible with aluminum and may cause an explosion. If you are unsure of a material's compatibility with aluminum, contact your coating supplier.

HAZARD: HAZARDOUS VAPORS - Paints, solvents, insecticides, and other materials may be harmful if inhaled, causing severe nausea, fainting, or poisoning.

PREVENTION

- Use a respirator or mask whenever there is a chance that vapors may be inhaled. Read all instructions with the spray material and mask to ensure that it will provide the necessary protection against the inhalation of harmful vapors.

HAZARD: GENERAL - May cause property damage or severe injury.

PREVENTION:

- Read all instructions and safety precautions for equipment and spray material before operating any equipment.
- Comply with all appropriate local, state, and national codes governing ventilation, fire prevention, and operation.
- Keep sprayer out of the reach of children.
- Hearing protection is recommended for extended use.
- Use eye protection to keep particles out of eyes.

HAZARD: ELECTRIC SHOCK HAZARD - May cause severe injury.

PREVENTION:

- Keep electrical cord plug and spray gun trigger free from paint and other liquids. Never hold cord at plug connections to support cord. Failure to observe may result in an electrical shock.

⚠ CAUTION

Use only a 3-wire extension cord that has a 3-blade grounding plug and a 3-slot receptacle that will accept the plug on the product. Make sure your extension cord is in good condition. When using an extension cord, be sure to use one heavy enough to carry the current your product will draw. For lengths less than 50 feet, use a No. 18 AWG extension cord. For lengths more than 50 feet, use a No. 14 or No. 16 AWG extension cord. An undersized cord will cause a drop in line voltage resulting in loss of power and overheating.

Wagner Spray Tech accessory extension cords recommended:

P/N 0090241 20 foot extension cord.

P/N 0090242 35 foot extension cord.

GROUNDING INSTRUCTIONS

This product must be grounded. In the event of an electrical short circuit, grounding reduces the risk of electric shock by providing an escape wire for the electric current. This product is equipped with a cord having a grounding wire with an appropriate grounding plug. The plug must be plugged into an outlet that is properly installed and grounded in accordance with all local codes and ordinances.

⚠ WARNING

Danger! Improper installation of the grounding plug can result in a risk of electric shock.

If repair or replacement of the cord or plug is necessary, do not connect the green grounding wire to either flat blade terminal. The wire with insulation having a green outer surface with or without yellow stripes is the grounding wire and must be connected to the grounding pin.

Check with a qualified electrician or serviceman if the grounding instructions are not completely understood, or if you are in doubt as to whether the product is properly grounded. Do not modify the plug provided. If the plug will not fit the outlet, have the proper outlet installed by a qualified electrician.

This product is for use on a nominal 120 volt circuit and has a grounding plug that looks like the plug illustrated below. Make sure that the product is connected to an outlet having the same configuration as the plug. No adapter should be used with this product.

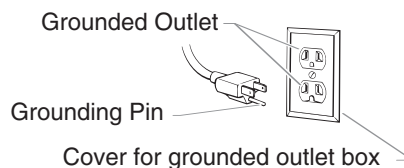

NOTE: This product is intended for home use.

CONTROLS AND PARTS

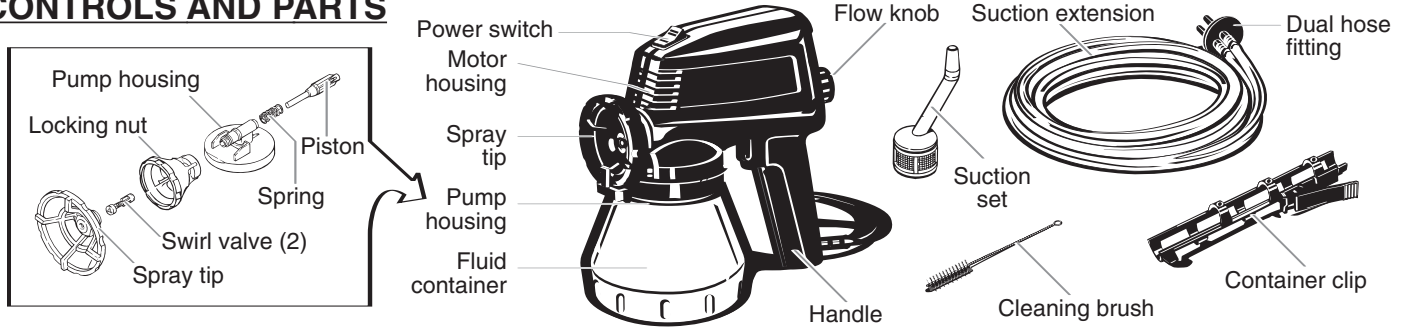

BEFORE YOU BEGIN

- NOTE:** It is important to mix the material thoroughly before you begin. Do not shake the material to mix it. Always stir the material gently but thoroughly before use.
- NOTE:** Remove any skin that has formed on the top of the material. Do not mix the skin into the material. The skin can break up and clog the sprayer. Older paint may need to be strained.

ONE-QUART SETUP

1. Fill the container with the material to be used.

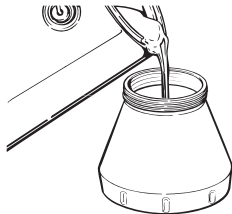

2. Place a few drops of household oil down the intake and return openings in the pump housing.

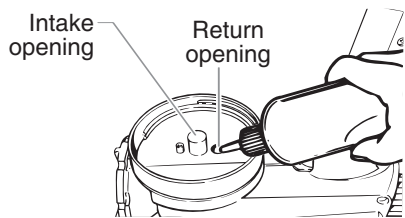

3. Insert the suction set into the intake opening and thread the container securely to the sprayer.

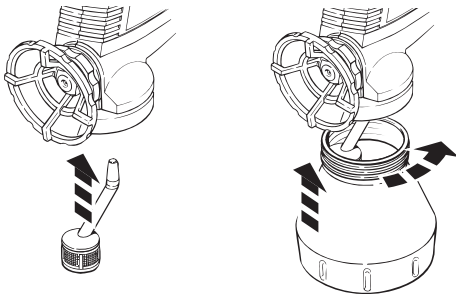

4. Plug in the unit.

CAUTION

Never tip the sprayer at more than a 45° angle when using the small container. Material could get into the motor housing and damage the sprayer.

SUCTION EXTENSION SETUP

1. Place a few drops of household oil down the intake (center) and return (back) openings in the pump housing.
2. Push the dual hose fitting into the intake and return openings on the bottom of the housing. The fitting with the ridge goes into the return opening.
3. Place the pump housing locking collar over the dual hose fitting and turn the locking collar clockwise until it locks securely.
4. Push the suction hose set onto the intake and return ports of the dual hose fitting.
5. Slide the intake hose through the container clip. You may need to pull the hoses slightly apart.
6. Press the suction set hose adapter onto the suction set.
7. Push the intake hose onto the suction set assembly. Make certain that the intake filter is in place on the suction set.
8. Submerge the suction set assembly into the material container and attach the container clip to the side to hold it securely. Make certain that the return line is inside the container.

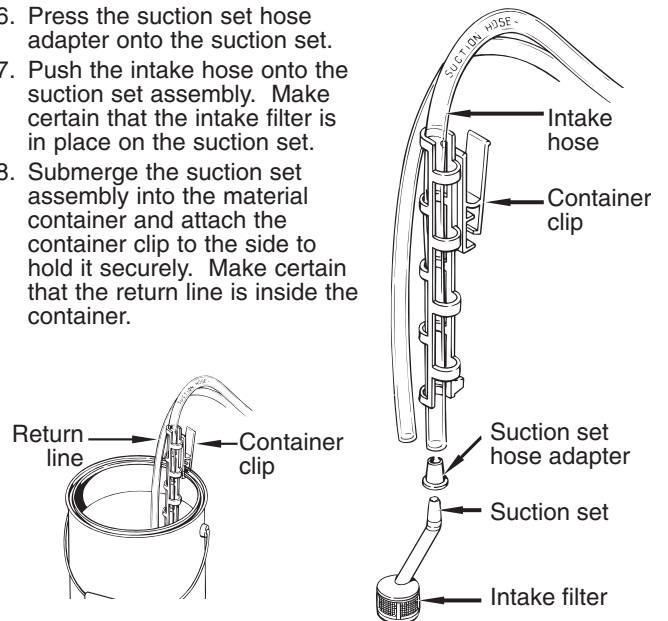
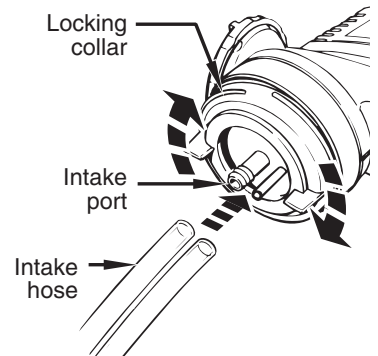
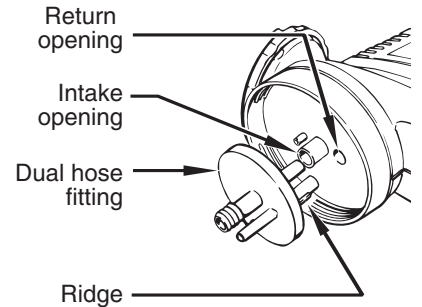

Read **PRIMING WITH SUCTION EXTENSION** instructions before spraying.

SELECTING THE PROPER TIP

WIDE ANGLE TIP

The wide angle tip produces a wide pattern that can be adjusted horizontally or vertically.

To adjust:

1. Make sure the sprayer is unplugged.
2. Loosen the wide angle tip by turning the tip counterclockwise 1/4 turn.
3. Turn the adjusting arm so that it is pointing down for a horizontal pattern. Turn the adjusting arm so that it is pointing to the side for a vertical pattern.
4. Tighten the tip firmly by hand.

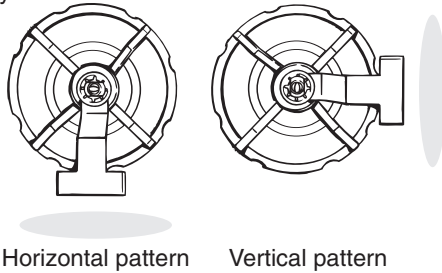

ROUND TIP

The round tip produces a round pattern. Use a round tip if the surface you are spraying is too small for use with the wide angle tip.

The round tip comes in three sizes available at your local retailer. Use the size that works best for the type of material you are spraying. The color of the tip center indicates its size:

1. **Blue** (light materials) - .023 inch (0.6mm) opening. This size works best for oil-based materials.
2. **Pink** (medium materials) - .031 inch (0.8mm) opening. This all purpose size works best for oil-based materials.
3. **Green** (heavy materials) - .039 inch (1.0mm) opening. This size works best for hard to spray, coarse materials.

STAIN TIP

The stain tip is an option included with some models. It has a specially designed opening for use with thin materials such as thin stains, sealers and waterproofers, and can be adjusted to reduce overspray. If you did not receive a stain tip and will be spraying one of these materials, the tip can be purchased at your local retailer.

The stain tip pattern is round with a fine spray. To adjust the spray pattern size and coarseness, turn the tip slightly counterclockwise to narrow the pattern and make the spray more coarse. Turn the tip slightly clockwise to widen the pattern and make the spray more fine.

IMPORTANT!

Make sure to tighten all spray tips firmly by hand. If the spray tip is not tightened firmly enough, the sprayer could leak or the tip could be damaged. Do not use a tool to tighten the spray tip. If the tip is too tight, it may be damaged.

SETTING THE POWER CONTROL

Your sprayer offers you two power levels: 100% (II) and 25% (I). The lower the power level, the closer you can get to your work and the less overspray you will have. Lower power levels give you greater control but require more time to cover an area.

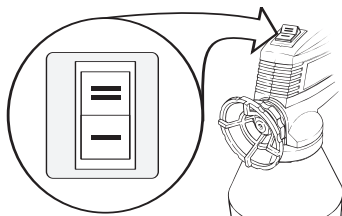

NOTE: In order to keep an even spray pattern, you will need to reduce the amount of material flowing to the gun as you reduce the power level. Turn the flow knob clockwise slowly to reduce the material flow.

To adjust, press the button on the top of the sprayer to to II for 100% or to I for 25% power.

NOTE: Always practice spraying on a piece of scrap wood or cardboard to test your spray pattern.

CAUTION

Do not get the power level control wet or the sprayer could be damaged. Be careful during use and cleanup.

FLOW CONTROL KNOB

The spray pattern is controlled by the flow control knob on the back of the sprayer, and by the thickness of the material being sprayed.

Turning the flow knob **counterclockwise** increases the amount of material flow. Turning the flow knob **clockwise** decreases the amount of material flow. To adjust the pattern:

1. Turn the flow knob fully **counterclockwise** to maximum.
 2. Squeeze the trigger and test the pattern on a piece of scrap wood or cardboard.
 3. Turn the flow knob **clockwise** until you have a good spray pattern.
- A poor spray pattern will concentrate the paint in the center of the spray and go on blotchy.

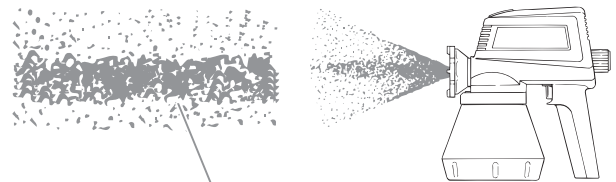
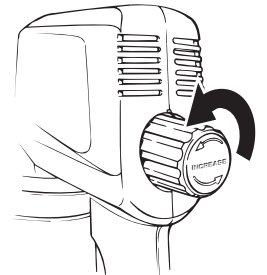

Poor spray pattern

- A good spray pattern has an even amount of material throughout the pattern in a fine spray and will go on smoothly.



Good spray pattern

NOTE: Always practice spraying on a piece of scrap wood or cardboard to test your spray pattern. Use the coverage rate recommended by the material's manufacturer.

NOTE: If you adjust the flow knob and still cannot get a good pattern, you may need to thin the material you are using.

MATERIAL THINNING

Always test spraying without thinning the material. Thin as required to achieve optimum spraying performance (refer to #3, **FLOW CONTROL KNOB**).

NOTE: If you are spraying with a material that needs to be thinned, make sure to follow the manufacturer's recommendations.

PRIMING WITH THE SUCTION EXTENSION

- The time needed to prime will vary from 30 seconds to 3 minutes depending upon the thickness of the material you are spraying.
- Thinning the material will speed up the prime time and will also increase the material flow rate. However, never exceed the thinning recommendations as listed on the container for the material you are using.
- Using the suction extension will decrease the material flow, so it will take longer to apply the same amount of material to the surface being sprayed.
- If your sprayer is properly cleaned and oiled and it takes longer than three minutes to prime, your piston and/or pump housing may be worn and will need to be replaced before using your suction set.

If you are using the suction extension, you will need to prime the sprayer by removing air from the system. To prime:

1. Turn the flow knob fully counterclockwise to maximum.
2. Make certain the sprayer is plugged in.
3. Hold the sprayer below the level of the paint. This will speed up the priming.

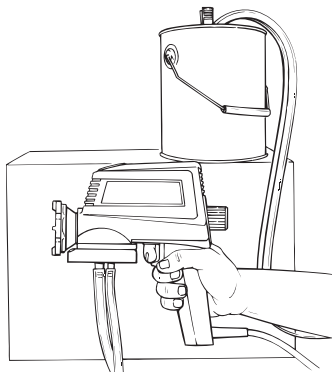

4. Squeeze the trigger and hold until all air is out of the system and material is flowing freely out of the sprayer tip. This should take about two minutes.



The suction set must remain completely submerged in the material. If it is not completely submerged and air is sucked into the system, the piston could seize. If the piston seizes, the sound the gun makes will change to a low hum and the gun will quickly become hot to the touch. Never run the sprayer when the piston is seized. Should this happen, clean the piston and the piston housing thoroughly using the cleanup procedures found in this manual.

SPRAYING



If material is leaking from the threads between the spray tip and the locking nut, turn off the sprayer immediately or the sprayer could be damaged.

The sprayer will leak from behind the spray tip if the swirl valve is not seated properly. If you notice material leaking from this area:

1. Unplug the sprayer immediately.

2. Remove the spray tip by turning it **counterclockwise**.

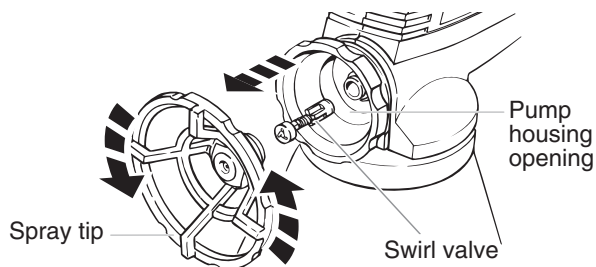

3. Remove the swirl valve and see if it needs to be cleaned or replaced (see page 8). Also check the pump housing opening for any dirt or other obstruction and clean if necessary.

4. Put the swirl valve back in place, making sure it can seat properly without any obstruction.

5. Thread on the spray tip by turning it **clockwise** and tighten firmly by hand.

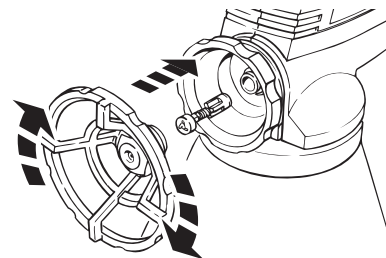

NOTE: The swirl valve that comes with your sprayer has a clear base. It is to be used with latex and oil-based paints only.

NOTE: If you will be spraying lacquers, make sure to use the optional swirl valve designed for lacquers, available for purchase by calling our toll free number. It has a grey base (look in **ACCESSORIES** for part number).

NOTE: When spraying, make sure your fluid container is at least half-filled with material. A container low on fluid will cause the sprayer to spit and will spray a poor pattern.

HOW TO SPRAY

Once you have achieved a good spray pattern on your test piece of wood or cardboard, it is time to begin spraying your work. The key to a good job is an even coating over the entire surface. This is done by using even strokes (follow the **TIPS**, below).

TIP: Keep your arm moving at constant speed and keep the sprayer at a constant distance from the surface. The best spraying distance is 10 to 14 inches between spray tip and the surface.

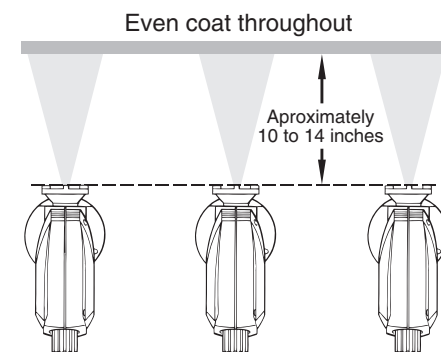

Keep stroke smooth and at an even speed.

TIP: Keep the sprayer at right angles to the surface. This means moving your entire arm back and forth rather than just flexing your wrist.

Light Coat Heavy Coat Light Coat

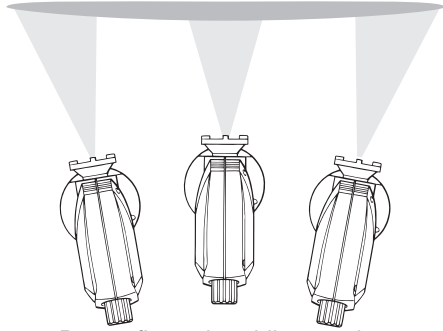

Do not flex wrist while spraying.

TIP: If you are spraying up, point the suction set toward the back of the container. If you are spraying down, point the suction set toward the front of the container.

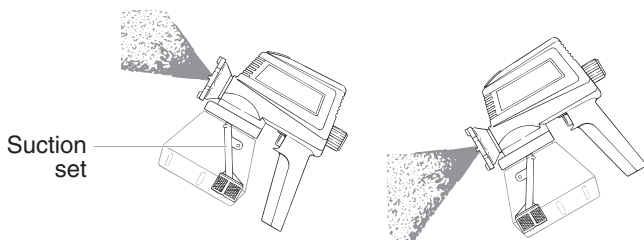

TIP: The sprayer should be triggered at the beginning of the stroke and released at the end of the stroke. This will save paint, avoid paint buildup at the end of the stroke, and prevent premature failure of the piston.

Proper way to trigger the sprayer

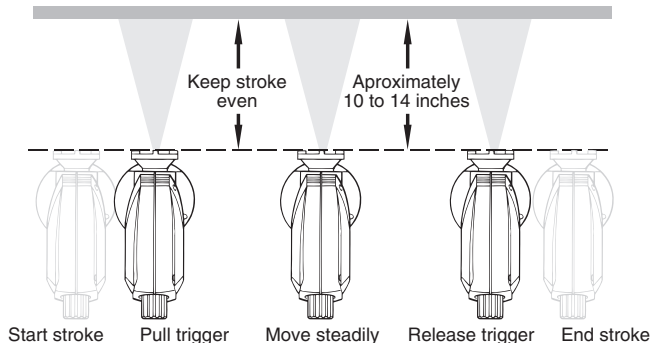

CAUTION

Never tip the sprayer at more than a 45° angle when using the small container. Material could get into the motor housing and damage the sprayer.

OVERSPRAY

Some sprayed materials create a cloud of paint. Some of that cloud will spray past your intended object and also bounce off of it. Wind and air currents may cause this cloud to drift onto surfaces not intended to be sprayed. You can control the amount of overspray and bounce-back by adjusting your flow and moving the sprayer closer to the work piece, but always make sure that you have a good spray pattern. Always test your pattern on a scrap piece of wood or cardboard, and make sure that you have drop cloths protecting anything not being sprayed. Anything you don't want painted that is in the area of your spraying surface should be covered or removed.

CLEANUP

IMPORTANT!

The most important thing to know about your sprayer is proper cleanup and maintenance. Dried paints and stains act like glue and cause moving pieces to stick. Taking the time to properly clean and maintain your sprayer helps it last longer and work right every time.

IMPORTANT!

It is also very important to use the correct cleaning solution when cleaning your sprayer.

- When using latex paints, use lukewarm, soapy water or Wagner Cleaner Lubricant when cleaning your sprayer and components (DO NOT USE HOT WATER!).
- When spraying with any other material such as stains or oil-based paints, use the type of solution recommended by the material's manufacturer on the original container.

WARNING

Never immerse electrical parts in water or any other liquid. Wipe the exterior of the sprayer with a damp cloth for cleaning. Always make sure the sprayer is unplugged before taking it apart for cleaning.

1. Unplug the sprayer.
2. Pour the remaining material back into the original container.
3. Fill the container half full of the cleaning solution appropriate to the type of material you sprayed.

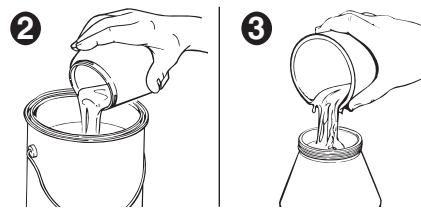

4. Plug in the sprayer.
5. Squeeze the trigger until the solution comes through the sprayer for several seconds.

CAUTION

Be sure to spray the solution onto a scrap piece of wood or cardboard to prevent property damage.

6. Unplug the sprayer.
7. Remove the container and properly dispose of the remaining solution.

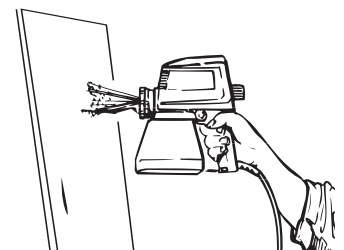

CLEANING THE SUCTION EXTENSION

1. Make sure the sprayer is unplugged.
2. Remove the suction set from the material container and submerge into a container of the solvent appropriate to the type of material you sprayed.
3. Plug in the sprayer, and squeeze the trigger and spray into a second container until the solvent coming through the sprayer is free of material.
4. Unplug the sprayer.
5. Remove the suction set from the cleaning solution.
6. Unlock the pump housing locking nut by turning it **counterclockwise**.

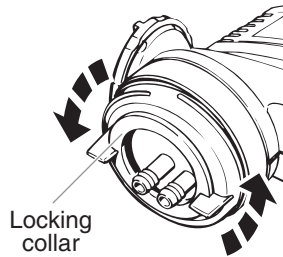

7. Pull the dual hose fitting out of the pump housing.

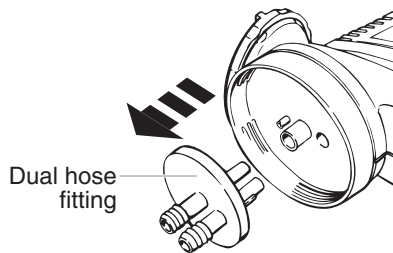

CLEANING THE PUMP HOUSING

1. Make certain the sprayer is unplugged.
2. Turn the spray tip **counterclockwise** until it is removed. Be careful not to lose the swirl valve.

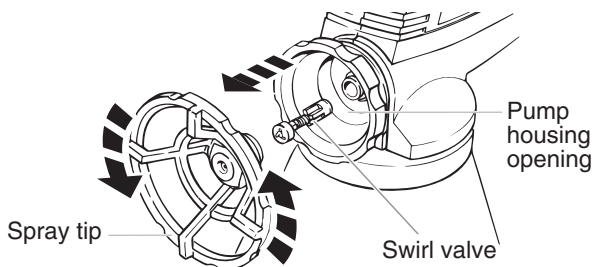

3. Pull out the swirl valve.
4. Turn the locking nut **counterclockwise** until it is removed.

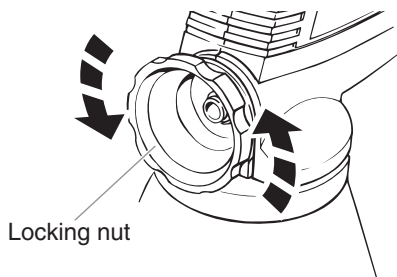

5. Slide the pump housing assembly off of the sprayer.

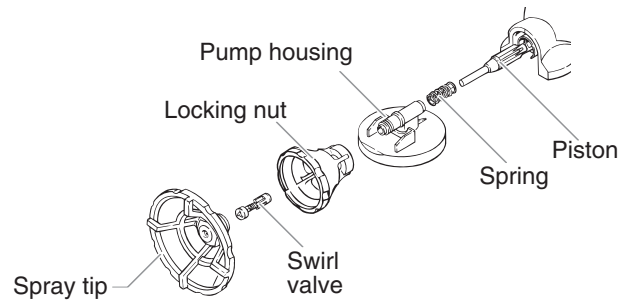

6. Pull the piston and spring off of the pump housing.
7. Pull the spring off of the piston.
8. Remove the fluid container and suction set.

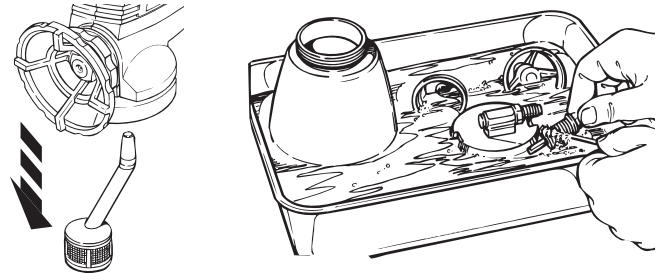

9. Clean all parts thoroughly with the brush provided using a solution appropriate to the type of material you sprayed.

CAUTION

Make sure to completely remove all material from the inside of the piston chamber by scrubbing with the brush. Even a small amount of material can dry like glue and keep the piston from moving, causing damage to the sprayer.

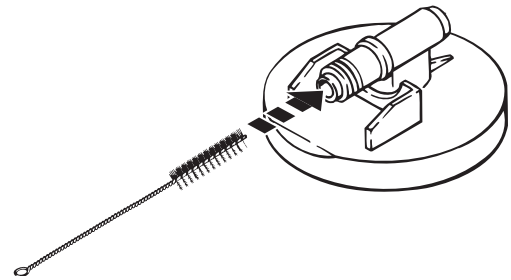

Make sure to keep the vent hole on the pump housing clean and unblocked or a vacuum can build up in the container and cause damage to the sprayer. A toothpick or straightened paper clip can be used to clean it.

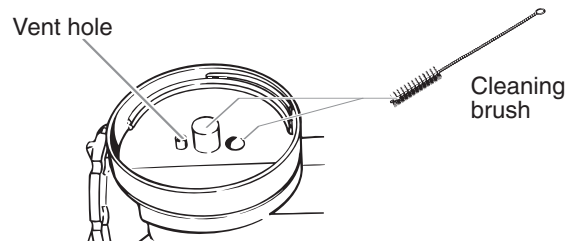

STORAGE

NOTE: Reassemble your sprayer before storing.

1. Slide the spring onto the front end of the piston.
2. Insert the piston into the back of the pump housing
3. Insert the pump housing assembly into the front of the sprayer.

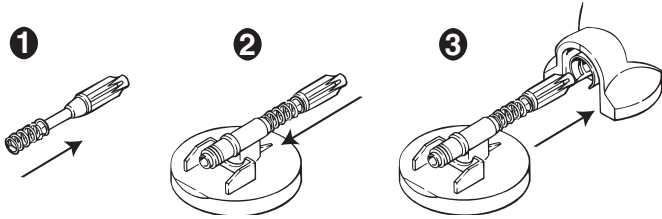

4. Place the locking nut onto the motor housing.
5. Press in while turning the locking nut **clockwise** and tighten firmly by hand.

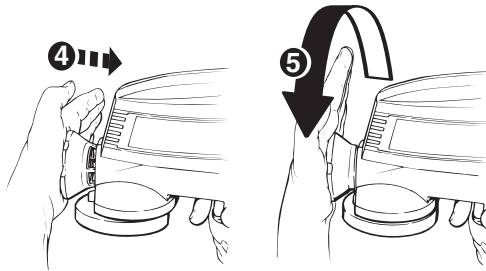

CAUTION

Do not cross-thread the locking nut. Make certain it is threaded correctly before tightening. Make certain that the pump housing is pushed far enough into the sprayer and the locking nut is screwed on tightly.

6. Insert the swirl valve into the front end of the pump housing.
7. Place the spray tip onto the pump housing and turn it **clockwise** until it is tightened securely.

LUBRICATING THE SPRAYER

NOTE: Lubricating your sprayer prior to storage is important to prolong the life of the pump housing components.

1. Turn the sprayer upside-down while the fluid container is removed.
2. Pour a small amount of standard household oil into both the intake and return openings on the pump housing.

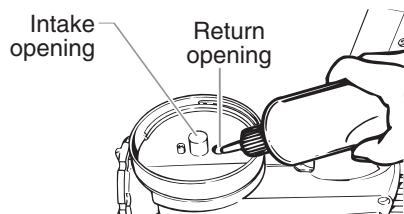

3. Plug in the sprayer.
4. Squeeze the trigger of the sprayer for 2 to 3 seconds while sprayer is still inverted as shown above. This works the household oil onto the piston and swirl valve. The oil protects the sprayer by keeping any extra material from drying and seizing the piston.
5. Replace the suction set and thread the fluid container onto the sprayer.

MAINTENANCE

Parts of your sprayer wear out with use and require regular replacement. They include the swirl valve, piston and spring. These parts are not covered by your sprayer warranty.

More abrasive materials such as latex paints and stains cause these parts to wear out faster than less abrasive materials such as oil-based paints and stains, thin stains and sealers.

REPLACING THE SWIRL VALVE

The swirl valve is shaped to cause the material to spin as it comes out of the sprayer. The spinning breaks the material up into a fine spray. As more material goes through the swirl valve, it wears out the valve and the shape of the valve changes. When it changes too much to produce a good spray pattern, the valve needs to be replaced.

- 1 Front view of a good swirl valve.
- 2 Front view of a swirl valve after spraying 7-10 gallons of latex paint. Replace.
- 3 Front view of a swirl valve after spraying 7-10 gallons of latex stain. Replace.

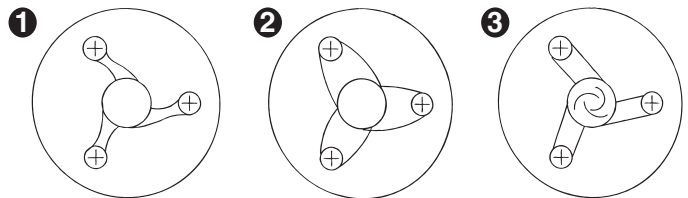

NOTE: The swirl valve that comes with your sprayer has a clear base. It is to be used with latex and oil-based paints only.

If you will be spraying lacquers, make sure to use the optional swirl valve designed for lacquers, available for purchase by calling our toll free number. It has a grey base.

1. Make certain that the sprayer is unplugged.
2. Turn the spray tip **counterclockwise** and remove.

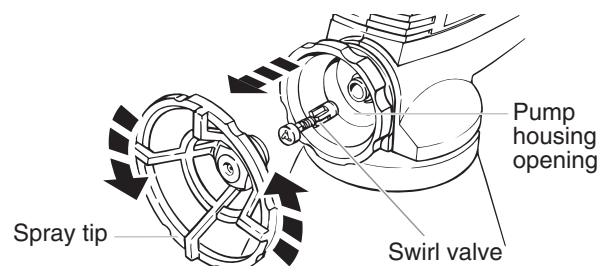

3. Pull the old swirl valve out of the pump housing and insert a new one.
4. Place the spray tip over the new swirl valve and tighten it securely by hand.

NOTE: Make sure to tighten all spray tips firmly by hand. If the spray tip is not tightened firmly enough, the sprayer could leak or the tip could be damaged. Do not use a tool to tighten the spray tip. If the tip is too tight, it may be damaged.

REPLACING THE PISTON AND SPRING

The average life of a piston and spring will vary depending on the types of material being sprayed.

NOTE: Replace the piston if the sprayer takes longer than 15 seconds to prime when well lubricated, or if there is an excess amount of material leaking, refer to the troubleshooting suggestions listed in this manual. Replace the spring if you notice that it is broken when you clean the sprayer.

1. Make certain the sprayer is unplugged.
2. Turn the spray tip **counterclockwise** until it is removed. Be careful not to lose the swirl valve.

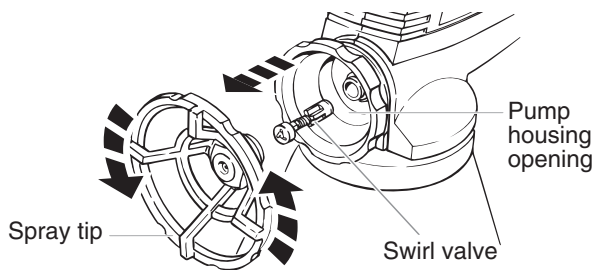

3. Pull out the swirl valve.
4. Turn the locking nut **counterclockwise** until it is removed.

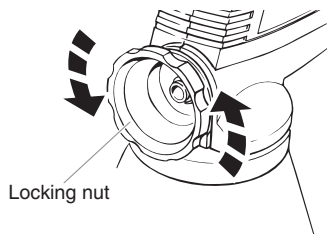

5. Slide the pump housing assembly off of the sprayer.
6. Pull the piston and spring off of the pump housing.
7. Pull the spring off of the piston and throw away the old piston.
8. Slide the spring onto the front end of the new piston.
9. Insert the piston into the back end of the pump housing.

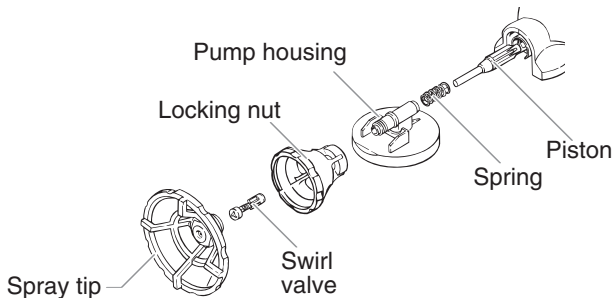

10. Insert the pump housing assembly into the front of the sprayer.
11. Place the locking nut onto the motor housing.
12. Press in while turning the locking nut **clockwise** and tighten firmly by hand.

CAUTION

Do not cross-thread the locking nut. Make certain it is threaded correctly before tightening. Make certain that the pump housing is pushed far enough into the sprayer and that the locking nut is screwed on tightly.

13. Insert the swirl valve into the front end of the pump housing.
14. Place the spray tip onto the pump housing and turn it **clockwise** until it is tightened securely.

ADDITIONAL REPAIRS

If you have any problems that are not solved by the troubleshooting section of this manual, please call Wagner Technical Service at 1-800-328-8251 Monday through Friday between 8:00 AM and 4:30 PM Central time. An automated Self-Help option is also available at 1-800-760-3844 and www.wagnerspraytech.com, seven days a week, twenty-four hours a day. If you suspect that you have a problem with the electrical system, or have any other problems not solved by the routine maintenance described in this manual, take your sprayer to the nearest authorized service center.

PRODUCT REGISTRATION CARD

Send in your product registration card or register online at www.wagnerspraytech.com. Proper registration will serve as proof of purchase in the event your original receipt becomes misplaced or lost. Returning this card will expedite the processing of your warranty. Be sure you write your unit's **date code** on the card before sending it. The date code is located at the base of the handle (for example, **T087R**). The additional information will also help us to develop new products that best meet your needs and desires.

TROUBLESHOOTING

PROBLEM

CAUSE

SOLUTION

Motor will not run.	<ol style="list-style-type: none"> 1. No power at wall outlet. Electrical problem or defective motor. 	<ol style="list-style-type: none"> 1. Try new wall outlet. Take to Authorized Service Center for repair.
Motor has a low hum and does not spray.	<ol style="list-style-type: none"> 1. Control knob turned in too far. 2. Seized piston. 	<ol style="list-style-type: none"> 1. Turn control knob counterclockwise. 2. Disassemble sprayer and clean.
Motor operates properly but does not spray.	<ol style="list-style-type: none"> 1. Failure to prime with 5 ft suction extension. 2. Loose or damaged suction tube. 3. Plugged or worn swirl valve. 4. Swirl valve missing. 5. Material too thick. 6. Plugged spray tip. 7. Intake filter plugged. 8. Control knob needs adjusting. 9. Worn piston. 	<ol style="list-style-type: none"> 1. Thin paint. Hold sprayer below level of paint can. Oil intake opening. 2. Tighten or replace. 3. Clean or replace as needed. 4. Put in swirl valve. 5. Thin material. 6. Clean tip. 7. Clean intake filter. 8. Adjust. 9. Clean and oil or replace.
Material spitting or globbing.	<ol style="list-style-type: none"> 1. Low on paint. 2. Paint too thick. 3. Loose suction set drawing in air. 4. Worn swirl valve. 5. Worn spray tip. 6. Control knob needs adjusting. 7. Worn piston. 	<ol style="list-style-type: none"> 1. Refill container. 2. Thin paint. 3. Clean and insert firmly in intake opening on pump housing. 4. Replace swirl valve. 5. Replace if worn. 6. Adjust. 7. Replace or clean and oil.
Excessive fogging.	<ol style="list-style-type: none"> 1. Pressure too high. 2. Holding sprayer too far from work surface. 	<ol style="list-style-type: none"> 1. Turn control knob clockwise to reduce pressure and flow. 2. Hold sprayer closer to work surface.
Runs and sags in paint.	<ol style="list-style-type: none"> 1. Arm movement too slow, holding spray gun too close to work surface or applying too much paint at one time. 	<ol style="list-style-type: none"> 1. See section on spraying (pages 5-6).
Material drips from spray tip guard.	<ol style="list-style-type: none"> 1. Guard is for safety and cannot be removed. Some dripping is unavoidable with some paints. 	<ol style="list-style-type: none"> 1. Use a small brush on drips that fall on surface being sprayed. Use a drop cloth.
No display on frequency module	<ol style="list-style-type: none"> 1. No power. 2. Module defective 	<ol style="list-style-type: none"> 1. Check to see if plugged in. 2. Take to Authorized Service Center for repair.
Module missing frequency	<ol style="list-style-type: none"> 1. Module defective. 	<ol style="list-style-type: none"> 1. Take to Authorized Service Center for repair.
Spraying erratic, module won't adjust	<ol style="list-style-type: none"> 1. Module defective. 	<ol style="list-style-type: none"> 1. Take to Authorized Service Center for repair.
Motor overheats.	<ol style="list-style-type: none"> 1. Seized piston. 2. Extension cord too long. 3. Operating continuously 	<ol style="list-style-type: none"> 1. Clean piston. 2. Replace with proper size. 3. Release trigger at end of pass, allow to cool
Material leaking from between spray tip and locking nut.	<ol style="list-style-type: none"> 1. Spray tip is loose. 2. Swirl valve not positioned properly. 3. Worn swirl valve. 4. Eroded pump housing 	<ol style="list-style-type: none"> 1. Tighten securely. 2. Unplug the sprayer, remove the spray tip and reposition the swirl valve. 3. Replace. 4. Replace pump housing

PARTS LIST • LISTE DE PIÈCES • LISTA DE PIEZAS

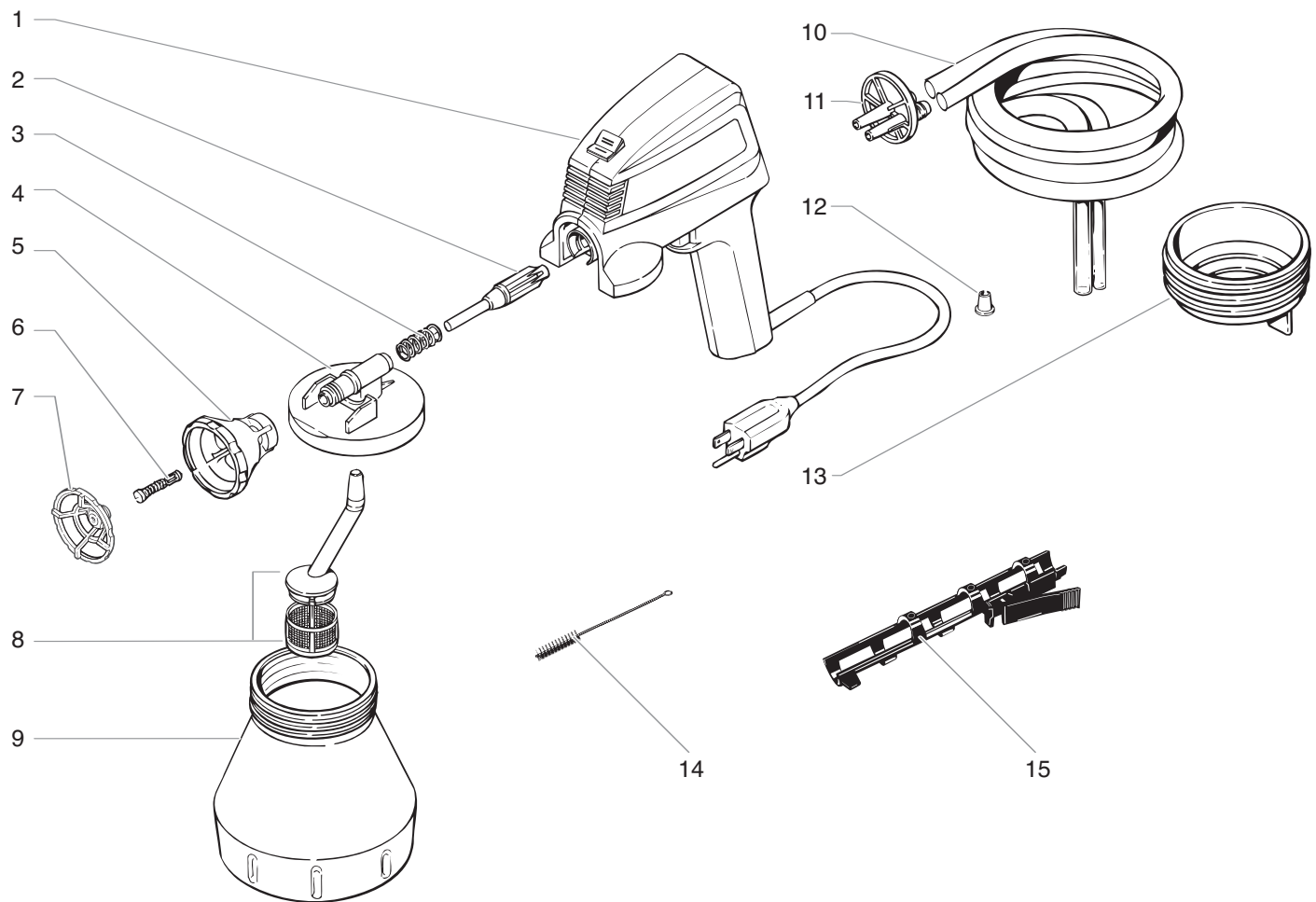

OPTIONAL ACCESSORIES • ACCESSOIRES OPTIONAL • ACCESORIOS OPCIONAL

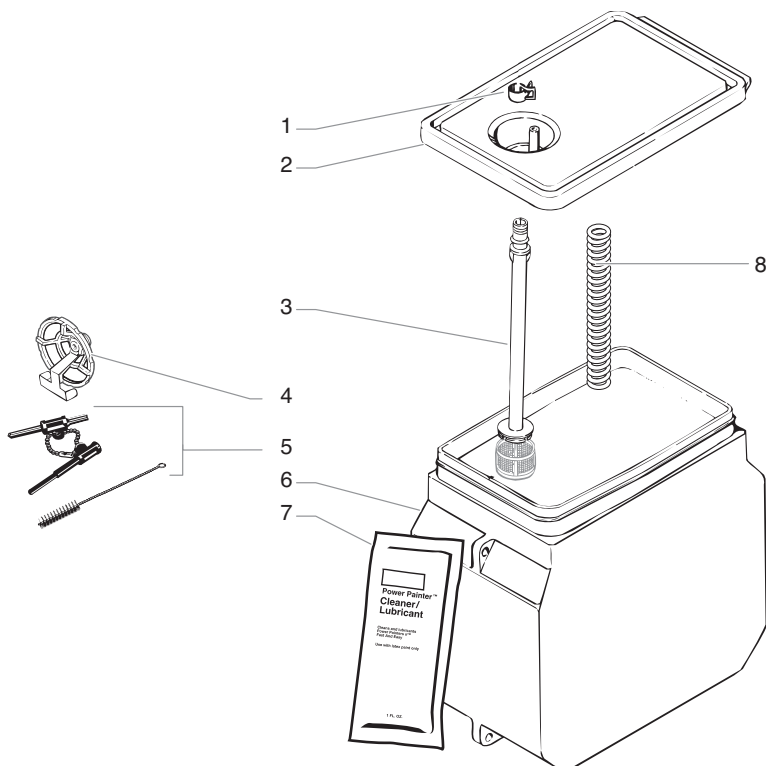

PARTS LIST

English

Item	Part No.	Description	Quantity
1	-----	Sprayer assembly	1
2	0199903	Piston	1
3	0016101	Piston spring	1
4	0285226	Pump housing	1
5	0272300	Piston locking nut	1
6	0272116	Swirl valve	3
7	0272135	Spray tip (.8mm pink)	1
8	0272109	Suction set	1
9	0285355	1-quart container	1
10	0518361	Dual hose set	1
11	0518354	Dual hose fitting	1
12	0500445	Suction set hose adapter	1
13	0285351	Pump housing locking collar	1
14	0280353	Container clip	1
15	0280205	Cleaning brush	1

LISTE DE PIÈCES

Français

Article	Pièce N°#	Description	Quantité
1	-----	Pulvérisateur	1
2	0199903	Piston	1
3	0016101	Ressort de piston	1
4	0285226	Carter du piston	1
5	0272300	Écrou de blocage du piston	1
6	0272116	Soupape rotative	3
7	0272135	Embout du pulvérisateur (0,8mm rose)	1
8	0272109	Dispositif d'aspiration	1
9	0285355	Contenant de produit	1
10	0518361	Tuyau souple double	1
11	0518354	Raccord pour tuyau souple double	1
12	0500445	Raccord du flexible du dispositif d'aspiration	1
13	0285351	Bague de blocage du corps de la pompe	1
14	0280353	Pince pour contenant	1
15	0280205	Brosse de nettoyage	1

LISTA DE PIEZAS

Español

Artículo	Pieza No.	Descripción	Cantidad
1	-----	Conjunto del pulverizador	1
2	0199903	Embolo	1
3	0016101	Resorte del émbolo	1
4	0285226	Caja de la bomba	1
5	0272300	Contratuerca del émbolo	1
6	0272116	Válvula de turbulencia	2
7	0272135	Boquilla (0.8 mm, rosada)	1
8	0272109	Unidad de succión	1
9	0285355	Envase	1
10	0518361	Conjunto de dos mangueras	1
11	0518354	Conexión de dos mangueras	1
12	0500445	Adaptador de la manguera de la unidad de succión	1
13	0285351	Collarín de seguridad de la caja de la bomba	1
14	0280353	Gancho del envase	1
15	0280205	Cepillo de limpieza	1

ACCESSORIES

English

Item	Part No.	Description	Quantity
1	9890215	Hose clamp	1
2	0518406	Backpack lid	1
3	0518309	Long suction tube	1
4	0272223	Wide angle spray tip	1
5	0280205	Brush with optional cleaning kit	1
6	0272375	Backpack	1
7	0280113	Cleaner/Lubricant packet	1
8	-----	Spring	1

ACCESSOIRES OPTIONAL

Français

Article	Pièce N°#	Description	Quantité
1	9890215	Pince pour flexible	1
2	0518406	Couvercle du contenant à dos	1
3	0518309	Long tube d'aspiration	1
4	0272223	Embout à grande angle	1
5	0280205	Brosse avec trousse de nettoyage facultative	1
6	0272375	Contenant à dos	1
7	0280113	Trousse de produits nettoyeurs/lubrifiants	1
8	-----	Ressort	1

ACCESORIOS OPCIONAL

Español

Artículo	Pieza No.	Descripción	Cantidad
1	9890215	Abrazadera de la manguera	1
2	0518406	Tapa del envase de mochila	1
3	0518309	Tubo de succión largo	1
4	0272223	Boquilla de ángulo abierto	1
5	0280205	Cepillo con juego de limpieza opcional	1
6	0272375	Mochila	1
7	0280113	Paquete de limpiador y lubricante	1
8	-----	Resorte	1

⚠ WARNING

Any attempt to open the motor housing or repair any electrical parts within the unit by anyone other than an authorized repair technician could cause serious injury and will void the warranty.

⚠ MISE EN GARDE

Toute tentative par une personne autre qu'un technicien autorisé d'ouvrir le carter du moteur ou de réparer un composant électrique pourrait entraîner des blessures graves et annulerait la garantie.

⚠ ADVERTENCIA

Si alguna persona que no es un técnico de reparación autorizado abre el alojamiento del motor y trata de reparar alguna pieza eléctrica de la unidad, puede ocasionar graves lesiones y se anulará la garantía.

WAGNER ONE-YEAR LIMITED WARRANTY - Keep on File

This product, manufactured by Wagner Spray Tech Corporation (Wagner) is warranted against defects in material and workmanship for one year following date of purchase if operated in accordance with Wagner's printed recommendations and instructions. This warranty does not cover damage resulting from improper use, accidents, user's negligence or normal wear. This warranty does not cover any defects or damages caused by service or repair performed by anyone other than a Wagner Authorized Service Center.

ANY IMPLIED WARRANTY OF MERCHANTABILITY OR FITNESS FOR A PARTICULAR PURPOSE IS LIMITED TO ONE YEAR FOLLOWING DATE OF PURCHASE. THIS PRODUCT IS DESIGNED FOR HOME USAGE ONLY. IF USED FOR COMMERCIAL OR RENTAL PURPOSES, THIS WARRANTY APPLIES ONLY FOR 30 DAYS FROM DATE OF PURCHASE. WAGNER SHALL NOT IN ANY EVENT BE LIABLE FOR ANY INCIDENTAL OR CONSEQUENTIAL DAMAGES OF ANY KIND, WHETHER FOR BREACH OF THIS WARRANTY OR ANY OTHER REASON. THIS WARRANTY DOES NOT APPLY TO ACCESSORIES.

If any product is defective in material and/or workmanship during the applicable warranty period, return it with proof of purchase, transportation prepaid, to any Wagner Authorized Service Center. (A listing of Service Center locations is enclosed with this product.) Wagner's Authorized Service Center will either repair or replace the product (at Wagner's option) and return it to you, postage prepaid.

Ceramic Spray Tip Lifetime Warranty

The ceramic spray tip you have purchased with your Wagner Power Painter is warranted against wear for the life of the Power Painter. The ceramic spray tip warranty does not cover damage resulting from improper use, accidents or user's negligence.

If the ceramic spray tip fails due to wear, return it, postage prepaid, to Wagner Spray Tech Corporation, Spray Tip Replacement, 1770 Fernbrook Lane, Minneapolis, MN 55447. Please include your name, complete address and telephone number with the spray tip. Allow 6 to 8 weeks for delivery.

SOME STATES DO NOT ALLOW LIMITATIONS ON HOW LONG AN IMPLIED WARRANTY LASTS OR THE EXCLUSION OF INCIDENTAL OR CONSEQUENTIAL DAMAGES, SO THE ABOVE LIMITATION AND EXCLUSION MAY NOT APPLY TO YOU.

THIS WARRANTY GIVES YOU SPECIFIC LEGAL RIGHTS, AND YOU MAY ALSO HAVE OTHER RIGHTS WHICH VARY FROM STATE TO STATE.

This equipment is covered by one or more of the following U.S. Patents: 2,99,646 - 3,116,879 - 3,445,068 - 3,876,154 - 3,899,134 - 3,680,789 - 4,036,438.

GARANTIE LIMITÉE D'UN AN - À conserver

Ce produit, fabriqué par Wagner Spray Tech Corporation (Wagner), est garanti contre les défauts de matériaux et de fabrication pendant un an suivant la date d'achat, s'il est utilisé conformément aux recommandations et directives imprimées par Wagner. Cette garantie ne couvre pas les dégâts qui résulteraient d'une mauvaise utilisation, les accidents, la négligence de l'utilisateur ou l'usure normale. Cette garantie ne couvre aucun dégât dû des opérations de maintenance effectuées par tout autre qu'un réparateur approuvé par Wagner.

TOUTE GARANTIE IMPLICITE DE QUALITÉ MARCHANDE OU DE CONFORMITÉ À UN USAGE PARTICULIER EST LIMITÉE À UN AN À PARTIR DE LA DATE D'ACHAT. CE PRODUIT N'EST CONÇU QUE POUR UNE UTILISATION PRIVÉE. DANS LE CAS DE LOCATION OU AUTRES APPLICATIONS PROFESSIONNELLES, CETTE GARANTIE SE LIMITE À 30 JOURS À PARTIR DE LA DATE D'ACHAT. WAGNER NE POURRA EN AUCUN CAS ÊTRE TENUE RESPONSABLE DE DOMMAGES-INTÉRÊTS INDIRECTES OU CONSÉCUTIFS, QUE CE SOIT POUR UNE RUPTURE DE CETTE GARANTIE OU TOUTE AUTRE RAISON. CETTE GARANTIE NE S'APPLIQUE PAS AUX ACCESSOIRES

Si un produit est défectueux, au niveau des matériaux ou de la fabrication, au cours de la durée applicable de la garantie, le renvoyer avec une preuve d'achat, port payé, à l'un des centres de service autorisé par Wagner. (Une liste des adresses de ces centres accompagne tous les produits). Le centre de service autorisé réparera ou remplacera le produit (au choix de Wagner) et le renverra, port payé, et utilisateur.

Garantie à vie de l'embout en céramique du pulvérisateur

L'embout livré avec ce produit Wagner est garanti contre l'usure pour toute la durée utile de l'appareil. Cette garantie ne couvre pas les dégâts résultant d'une mauvaise utilisation du produit, d'accidents ou d'une négligence de l'utilisateur.

Si l'embout en céramique du pulvérisateur s'use, le renvoyer, port payé, à Wagner Spray Tech Corporation, Spray Tip replacement, 1770 Fernbrook Lane Minneapolis, Minnesota 55447 (USA). Prière de joindre le nom, l'adresse et le numéro de téléphone de l'utilisateur. Compter un délai de livraison de 6 à 8 semaines.

CERTAINS ÉTATS OU PROVINCES NE PERMETTENT PAS LA LIMITATIONS DE LA DURÉE DE LA GARANTIE IMPLICITE OU L'EXCLUSION DES DOMMAGES-INTÉRÊTS INDIRECTES OU ACCESSOIRES, LES RESTRICTIONS APPARAISSANT AUX PRÉSENTES POURRAIT DONC NE PAS S'APPLIQUER À UTILISATEUR.

LA PRÉSENTE GARANTIE CONFÈRE DES DROITS PRÉCIS À UTILISATEUR, MAIS CELUI-CI POURRAIT AVOIR D'AUTRES DROITS EN VERTU DES LÉGISLATIONS LOCALES..

Cet équipement est couvert par un ou plusieurs de ces brevets américains: 2.99.646 - 3.116.879 - 3.445.068 - 3.876.154 - 3.899.134 - 3.680.789 - 4.036.438.

GARANTÍA LIMITADA POR UN AÑO - Manténgala archivada

Este producto, fabricado por Wagner Spray Tech Corporation (Wagner), está garantizado contra defectos de materiales y de mano de obra por un año a partir de la fecha de compra, si se utiliza de acuerdo con las instrucciones y recomendaciones especificadas por Wagner. Esta garantía no cubre daños producidos por uso indebido, accidentes, negligencia del usuario o desgaste normal del producto. Tampoco cubre defectos o daños producidos por reparaciones o mantenimiento no realizados por un Centro de servicio autorizado de Wagner.

CUALQUIER GARANTÍA IMPLÍCITA DE COMERCIALIZACIÓN O DE BUEN ESTADO PARA PROPÓSITOS ESPECÍFICOS ESTÁ LIMITADA POR UN AÑO A PARTIR DE LA FECHA DE COMPRA. ESTE PRODUCTO SÓLO HA SIDO DISEÑADO PARA USO DOMÉSTICO. SI SE LE DA USO PROFESIONAL Y DE RENTA, ESTA GARANTÍA TIENE UNA DURACIÓN DE 30 DÍAS A PARTIR DE LA FECHA DE COMPRA. BAJO NINGUNA CIRCUNSTANCIA WAGNER SE RESPONSABILIZARÁ POR CUALQUIER DAÑO ACCIDENTAL O COMO CONSECUENCIA DEL USO DEL PRODUCTO, YA SEA POR LA VIOLACIÓN DE ESTA GARANTÍA O POR CUALQUIER OTRA RAZÓN. ESTA GARANTÍA NO INCLUYE LOS ACCESORIOS.

Si cualquier producto presentara defectos de materiales y/o de mano de obra durante el período válido, devuélvalo con el recibo de compra y el flete pagado a cualquier Centro de servicio autorizado de Wagner (este producto viene con una lista de los Centros de servicio). El Centro de servicio autorizado de Wagner reparará o reemplazará el producto (de acuerdo a su criterio) y se lo devolverá haciendo uso de los gastos de flete ya pagados.

Garantía vitalicia de la boquilla rociadora de cerámica

La boquilla rociadora de cerámica que usted ha adquirido con su equipo rociador de pintura Wagner está garantizada contra desgaste por el tiempo que dure su rociador. La garantía de la boquilla de cerámica no cubre daños producidos por uso indebido, accidentes o negligencia del usuario.

Si la boquilla de cerámica falla, debido a desgaste, devuélvala con franqueo pagado a Wagner Spray Tech Corporation, Spray Tip Replacement, 1770 Fernbrook Lane Minneapolis, Minnesota 55447. Por favor, junto con la boquilla, incluya su nombre, su dirección completa y su número de teléfono. La boquilla se le devolverá en de 6 a 8 semanas.

ALGUNOS ESTADOS NO PERMITEN LIMITACIONES DE TIEMPO A LAS GARANTÍAS IMPLÍCITAS NI TAMPOCO LA EXCLUSIÓN DE DAÑOS ACCIDENTALES O COMO CONSECUENCIA DEL USO DEL PRODUCTO, POR LO QUE ES POSIBLE QUE LA LIMITACIÓN ANTERIOR NO SE APLIQUE A SU CASO PARTICULAR.

ESTA GARANTÍA LE OTORGA CIERTOS DERECHOS LEGALES ESPECÍFICOS Y TAMBIÉN PUEDE ACCEDER A OTROS DERECHOS QUE VARIAN DE UN ESTADO A OTRO.

Este equipo está cubierto por una o más de las siguientes patentes de EE.UU.: 2.99.646 - 3.116.879 - 3.445.068 - 3.876.154 - 3.899.134 - 3.680.789 - 4.036.438.



Wagner Spray Tech Corporation
1770 Fernbrook Lane
Minneapolis, Minnesota 55447
Telephone 1-800-328-8251

Copyright © 2001 Wagner Spray Tech Corporation.
All rights reserved, including right of reproduction in
whole or in part, in any form. Printed in China.