

the Backyard  
**ORGANIZER**<sup>®</sup>  
by *Suntrellis*<sup>®</sup>

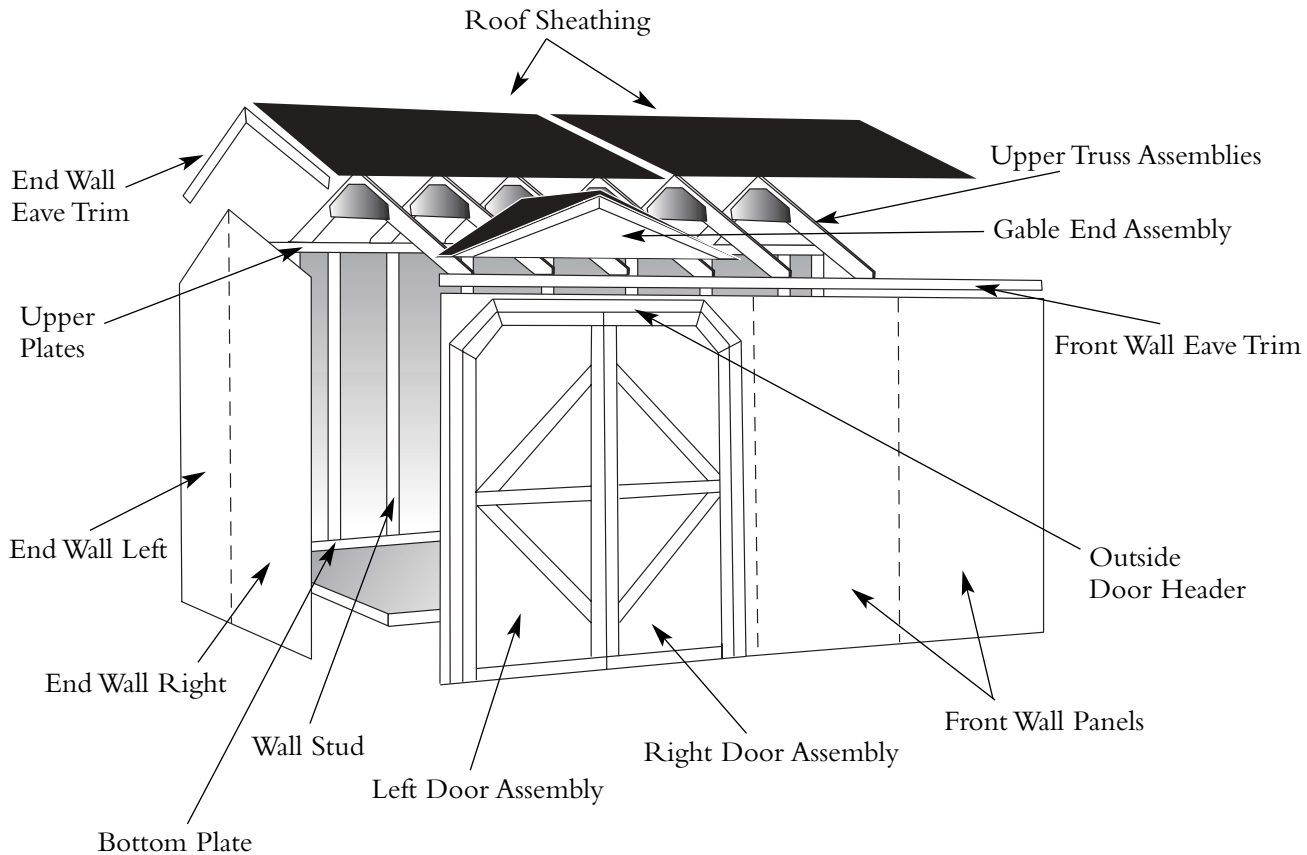

Catskill Building Kit

<b>Contents:</b>											
<p><b>Frame:</b></p> <p><b>Main Truss Components:</b></p> <ul style="list-style-type: none"> <li>Upper Truss Assemblies (16)(D)</li> <li>Gussets (14) (G)</li> <li>17 Wall Studs 70<sup>3</sup>/<sub>4</sub>" (M)</li> <li>End Wall Vertical Cross Brace (2)(S)</li> <li>End Wall Horizontal Cross Brace (2)(R)</li> <li>F/R Wall Bottom Plate 83<sup>1</sup>/<sub>2</sub>" Component (8)(L)</li> <li>F/R Wall Top Plate 8' Component (2)(K)</li> <li>F/R Wall Top Plate 35<sup>1</sup>/<sub>2</sub>" Component (4)(J)</li> <li>Door Jacks 68<sup>3</sup>/<sub>16</sub>" (2)(X)</li> <li>Inside Door Header (1)(Y)</li> <li>Outside Door Header (1)(CD)</li> </ul>	<p><b>Nails/Screws:</b></p> <p>2" x 3" Blocking</p> <p><b>Nail Size:</b></p> <table style="width: 100%; border: none;"> <tr> <td>1<sup>3</sup>/<sub>4</sub>" Nails</td> <td style="text-align: right;">1030 pieces</td> </tr> <tr> <td>3" Nails</td> <td style="text-align: right;">220 pieces</td> </tr> <tr> <td>1<sup>3</sup>/<sub>4</sub>" Screws</td> <td style="text-align: right;">15 pieces</td> </tr> <tr> <td>Barrel Bolt</td> <td style="text-align: right;">1 piece</td> </tr> <tr> <td>Latch</td> <td style="text-align: right;">1 piece</td> </tr> </table>	1 <sup>3</sup> / <sub>4</sub> " Nails	1030 pieces	3" Nails	220 pieces	1 <sup>3</sup> / <sub>4</sub> " Screws	15 pieces	Barrel Bolt	1 piece	Latch	1 piece
1 <sup>3</sup> / <sub>4</sub> " Nails	1030 pieces										
3" Nails	220 pieces										
1 <sup>3</sup> / <sub>4</sub> " Screws	15 pieces										
Barrel Bolt	1 piece										
Latch	1 piece										
<p><b>Siding Panels:</b></p> <ul style="list-style-type: none"> <li>End Right (2)(PR)</li> <li>End Left (2)(PL)</li> <li>Left Door Assembly(Z)</li> <li>Right Door Assembly(A1)</li> <li>Front/Rear Center 4' x 78<sup>1</sup>/<sub>2</sub>" Panel (4)(O)</li> <li>Front Right 35<sup>1</sup>/<sub>2</sub>" x 78<sup>1</sup>/<sub>2</sub>" Panel (1)(B1)</li> <li>Rear Right/Left 11<sup>1</sup>/<sub>2</sub>" x 78<sup>1</sup>/<sub>2</sub>" Panel (2)(N)</li> </ul>											
<p><b>Trim:</b> Roof Sheathing 8 Pieces (J2, K2, J1, K1)</p> <ul style="list-style-type: none"> <li>Gable End Assembly (G1)</li> <li>Gable Brace (G2)</li> <li>Gable Sheathing (L1)</li> <li>1" x 3" end wall eave trim (4) (Q1)</li> <li>1" x 3" end wall corner trim (4) (R1)</li> <li>1" x 4" F/R wall corner trim (4) (S1)</li> <li>2" x 3" F/R wall eave trim (4) (U1, U2)</li> </ul>											



# Before you Begin

Read the instructions before you begin assembly. Assembly is easiest if the order of the instructions is maintained.

## Required Tools

- Hammer
- Carpenters Level
- Measuring Tape
- Pencil
- Minimum 6' Step Ladder
- Phillips Screwdriver



## Optional Tools

- Chalk Line
- Carpenters Square
- Electric Drill with Screw Bit

## Additional Requirements/Information

- Some of the components and subassemblies of your building kit are heavy and require the assistance of another individual to lift, stabilize, position or fasten together. This kit is designed to be assembled by at least two individuals.
- It is recommended that you wear safety glasses, heavy work boots, and gloves throughout the assembly process.
- Always ensure that you begin with a level surface and retain all corners and perpendiculars square and all walls plumb throughout the assembly process.
- Always check and double check squareness before finally securing a component. This will ensure that subsequent steps remain hassle free and that components fit properly.
- Please check municipal bylaws before constructing.

STEP

# 1

## Site Preparation

- Site must be leveled. An improperly leveled site will result in an equally unlevel flooring system which in turn will hamper the assembly process and fit of your building kit. The use of crushed stone will allow for a gradeable surface on especially difficult sites.
- Take advantage of natural drainage, and avoid positioning building on the lowest part of your yard in order to prevent puddling and excessive moisture around your building. A moisture barrier such as plastic film or landscaping fabric may be used on the building site, to discourage grass and weed growth and reduce ground moisture.

STEP

# 2

## Floor System

**(A)** Before assembling your building, you must choose and construct a flooring system. Recommended is the optional pre-cut floor kit, which is custom designed to fit your building, and provides a lasting treated wood foundation. If a concrete slab or alternate wood foundation is used in place of the optional floor kit, then please note the following guidelines for a proper fit.

**(B)** Your Backyard Organizer is designed such that the wall frame sits on the edge of a floor surface or a sill plate while the siding overhangs the floor edge or sill plate by an additional 1 1/2".

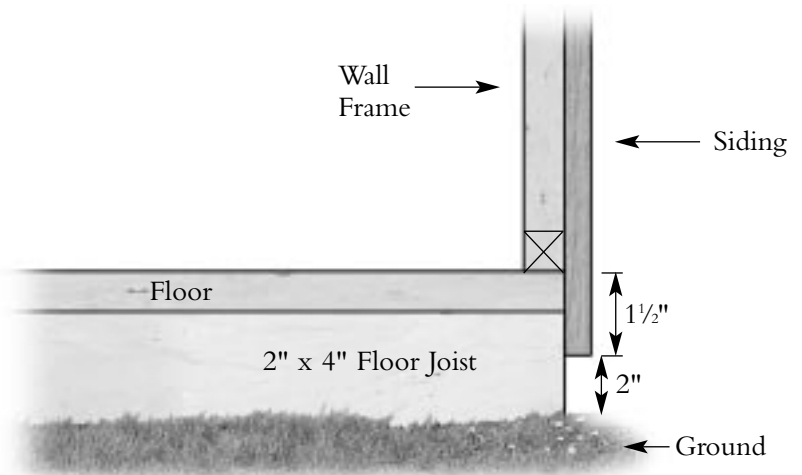

The bottom siding edge must clear the ground by a minimum 2" such that the siding edges are not in direct contact with ground moisture. On a concrete slab, this may require a coupled 2" x 4" wooden sill plate to anchor the building.

**(C)** In the case of a wooden floor structure a 2" x 4" floor truss with desired flooring on the surface should be sufficient for most applications. In either case the exterior dimensions of your floor or sill plates must be exactly 167" x 95 1/4".

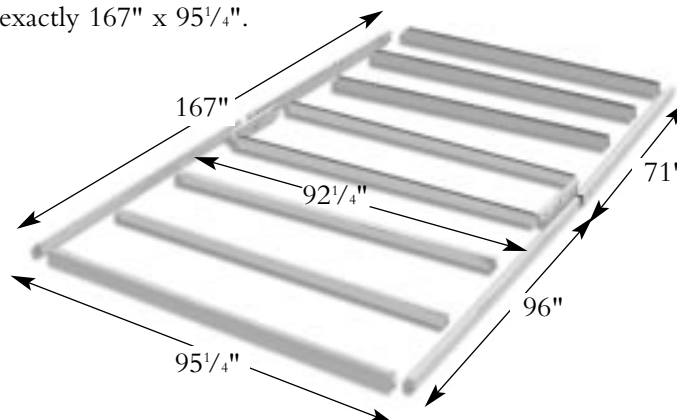

# Floor System

**D** The floor should be measured and marked along each side every 24" on center from the front and the rear to show proper truss placement. 2" x 3" temporary blocking is included to help erect the walls. For the Catskill model, they should be fastened where the two END walls will be erected. The upper surface of the blocking measuring 1 1/2" from the floor surface to ensure proper wall alignment.

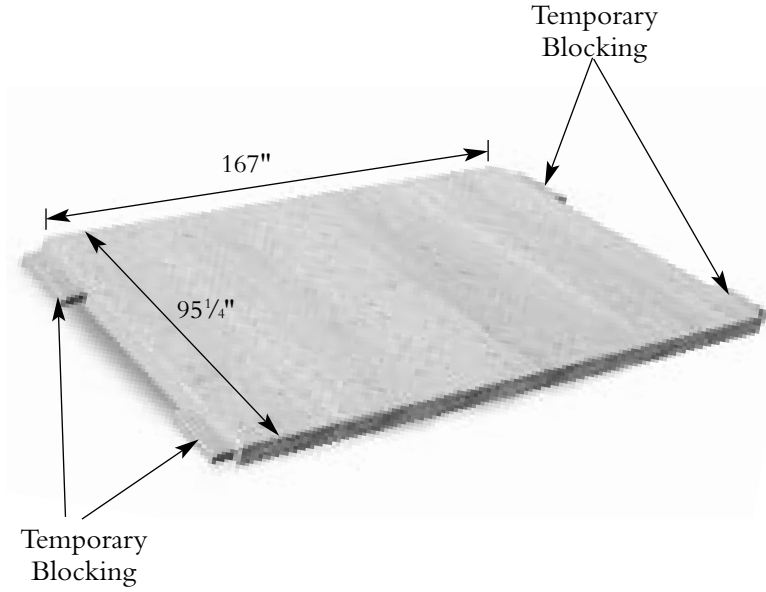
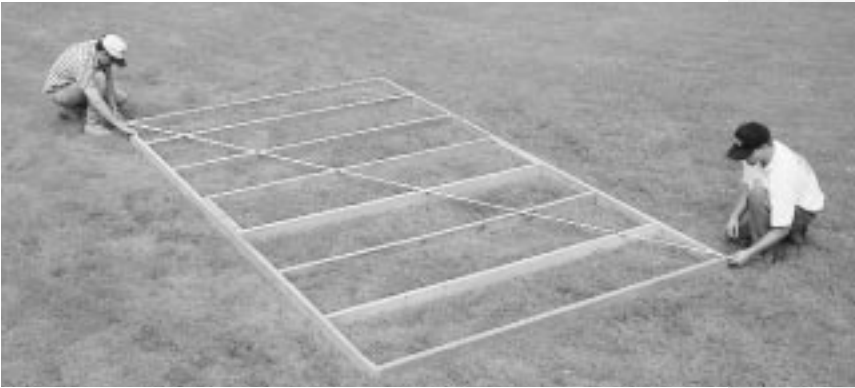

*Ensure floor is square and level before constructing building!!!*



Catskill Building Kit

# Assembling Main Trusses

STEP

3



**A** On the floor surface, lay out 2 truss components (D), such that the joining ends are tight and even. Wooden gusset plates (G) will be used over the center joint between the two roof truss components. Spacing of trusses should reach 95 1/4" at the base of the truss assembly.



**B** Attach center roof truss gusset to top of truss, allowing a gap between gusset plate and the top surface of the truss. Attach as per illustrated nailing pattern with 16 - 1 3/4" nails.



**C** Carefully turn assembly over and repeat for other side of the assembly. There will be 8 completed truss assemblies.

6 of these will have a gusset plate on both sides of the truss assembly as noted above. Two of these assemblies will have a gusset plate on one side only, as they will be positioned against the two end walls later in the assembly of the building.

Place finished truss away from work area, and repeat process for the remaining truss assemblies.

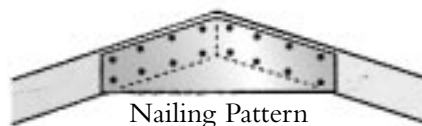

# End Wall Assembly

STEP

4

- A** On a flat surface, obtain a 87" (S) and an 90<sup>1</sup>/<sub>4</sub>" (R) notched cross brace and fasten at center notch with a 1<sup>3</sup>/<sub>4</sub>" nail. The (S) brace becomes the vertical brace running top to bottom of the wall while the (R) brace becomes the horizontal brace.



- B** With the exterior siding surface facing upwards, obtain right end right wall panel (PR) and position on the cross brace such that the panel fits on the center of the vertical cross brace.



- C** Ensure that the bottom of the cross brace is positioned 1<sup>1</sup>/<sub>2</sub>" from the bottom edge of the siding panel. Tack 1<sup>3</sup>/<sub>4</sub>" nail in the top and bottom through siding into vertical brace ensuring alignment along vertical brace.



Catskill Building Kit

## End Wall Assembly



- D** Obtain right end left wall panel (PL) and ensure the siding at the peak is aligned.

Tack a nail through siding of right panel and through siding of left panel and into vertical cross brace at top and bottom and then continue to nail every 8" from top to bottom.



- E** The end wall panels can then be nailed to the horizontal cross brace. First, adjust the brace to a level position such that it measures the same distance to the bottom edge of the siding on both the left and right panel. Mark this position on the exterior of the end wall with either a chalk line or a pencil. Nail at each end, double-check position and then nail every 8" inches through the siding into the horizontal brace.

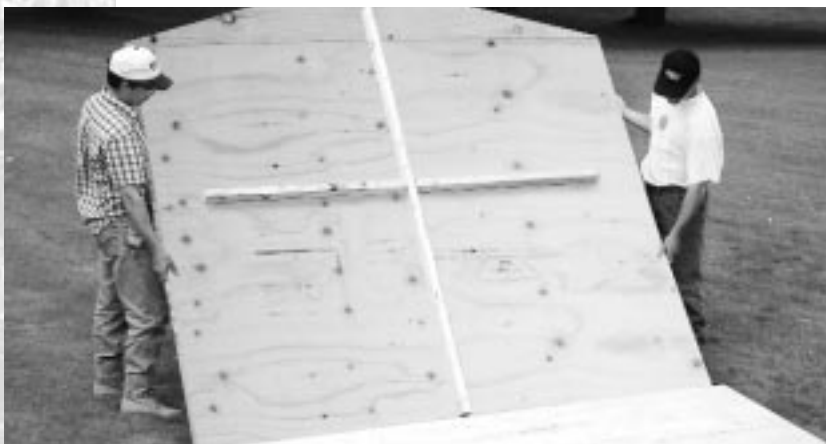

- F** Carefully place assembly aside and repeat Step D for the second end wall assembly (PR, PL). Please note: The final strength of the wall is not achieved until it is assembled with the remaining wall panels, therefore, the wall should not be moved on its flat but instead lifted to an upright position and moved to one side and then positioned flat until later in the assembly of the building.

# Rear Wall Assembly

STEP

5

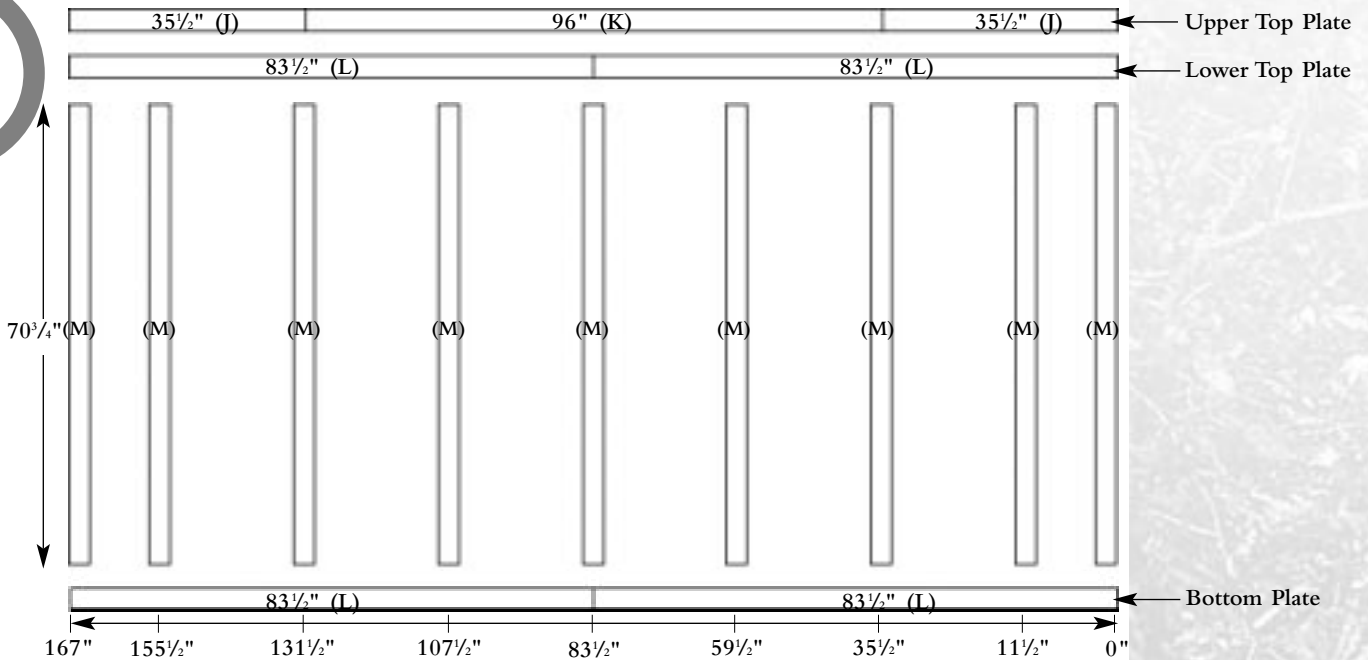

**A** Obtain the rear wall studs and the top plate components and place on a flat surface as per illustration.

The wall consists of 9 vertical studs (M), and a lower and upper top plate. The upper top plate is made of an 8' component (K) in the center with 2-35½" (J) components on each side.



**B** The lower top plate consists of two 83½" (L) components. Lay these out end to end and arrange studs perpendicular with spacing as follows. With the first stud at the far right the second should be spaced 11½" to the right and then at 24" intervals, ending with a 11½" space on the far left. Nail each of these from the bottom plate into the studs with two 3" nails. Obtain the 8' (K) and 35½" (J) upper top plate components and place over the lower top plate components as per illustration. Fasten with 3" nails along top plate.



Catskill Building Kit

## Rear Wall Assembly



- C** Obtain siding components (N), and (O) and arrange on studs with the exterior of the siding facing up, such that the seams align with the studs. (N) will go on the far left. 3 siding panels marked (O) will be positioned to the right, and finally siding panel (N) will be positioned to the far right.

It is recommended that the siding panels be arranged on the studs before fastening to ensure that they cover without exceeding the 167" length of the wall frame.



- D** The panels must be  $1\frac{1}{2}$ " below bottom plate. The panels should be fastened at the bottom corners first, then when studs are squared with the panel, fastened at the top corners.



- E** Once panels are arranged on studs, they can be fastened starting with the panel to the left.

# Rear Wall Assembly

**F** Once fastened at each corner secure the next panel and tack on the bottom corners, ensuring squareness with bottom plate. The studs can then be squared with the panel by lining up with the siding profile. The top of the siding should be tacked along each stud. Repeat process for remaining panels. When all panels are positioned and secured, check for squareness of the wall assembly by measuring from opposite corners (i.e. bottom right to top left). These measurements should be the same. When squareness of the wall assembly is assured, all the panels can be nailed into the studs and top plate every 8". The rear wall can now be placed aside.



*The wall assembly is very heavy and it is recommended that at least three individuals assist in moving or positioning the rear wall.*

STEP  
**6**

# Front Wall Assembly

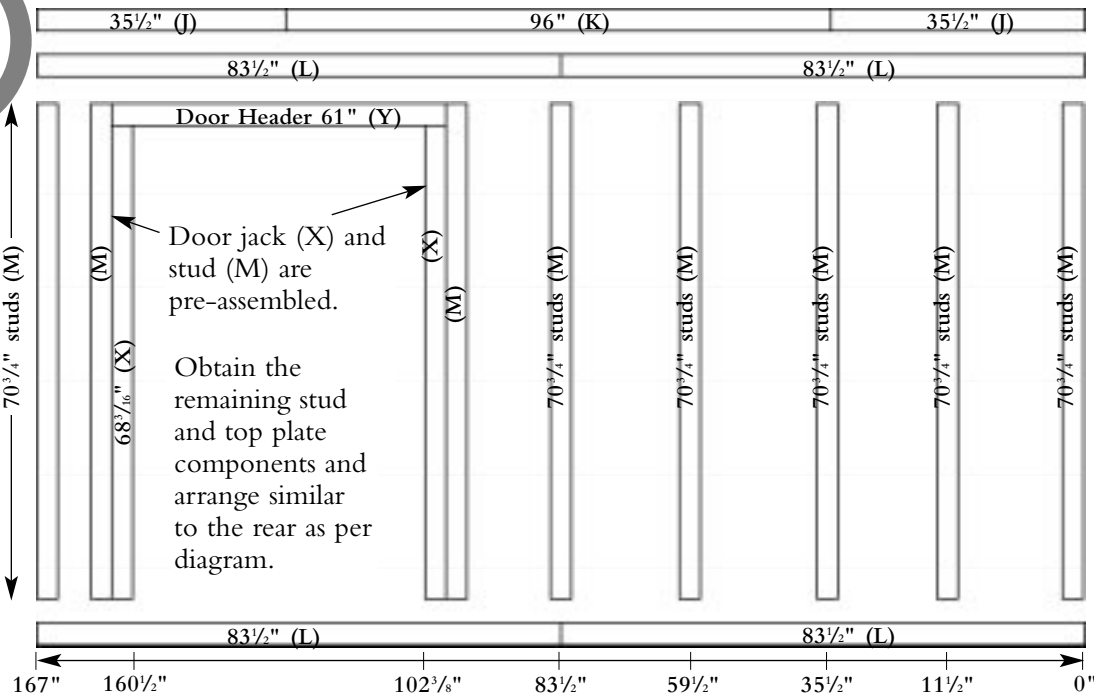

Catskill Building Kit

## Front Wall Assembly

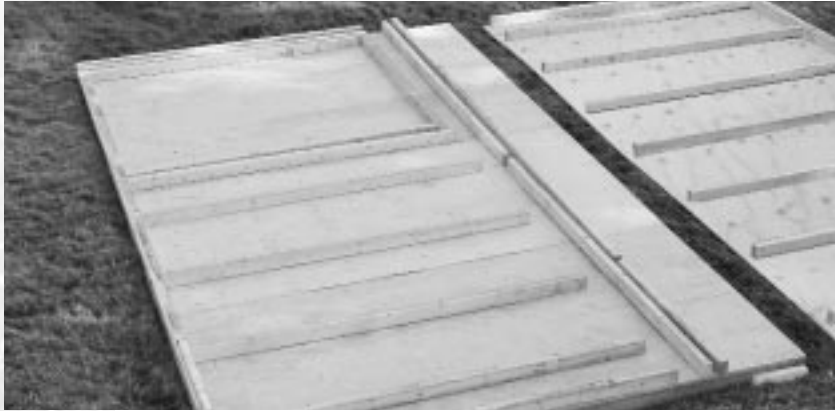

- A** The front wall frame consists of 8-70<sup>3</sup>/<sub>4</sub>" (M) studs, 2-68<sup>3</sup>/<sub>16</sub>"(X) door jacks, 1-61"(Y) door header. Note the spacing as per the diagram and lay out the components as illustrated. (Pg .11)

NOTE: 2 door studs (M) and 2 door jacks (X) are pre-assembled.



- B** The front wall has a double stud/door jamb and door header assembly that can be fastened before nailing to top plate, but noting spacing required for door header.

NOTE: Header should be nailed flush with top of studs.



- C** Nail remaining studs in a similar fashion as that of the rear and again fasten the remaining top plate components at an offset to the first top plate. Starting from left, place the left door assembly (Z), right door assembly(A1), a (O) siding panel and a (B1) siding panel over the secured frame. The door assemblies will require blocking under the center to ensure a level surface for fastening.



- D** Again siding must overhang bottom edge of studs by 1<sup>1</sup>/<sub>2</sub>".

As in the rear assembly, align the panels and the studs at the seams and working from the left and ensure squareness. Left door assembly (Z) will be installed first.

# Front Wall Assembly

**E** Tack first at the corners and ensure that the panels are square and aligned at the top and bottom before finally nailing siding every 8" into studs and top plate.

NOTE: There will be a 1/2" gap between doors.



**F** 3" nails should be used every 8" where the outside door jamb sits on the inside double stud on the front wall frame.



**G** Install remaining panels (O, B1) in a similar fashion to the rear wall, first tacking corners, checking squareness, aligning studs and finally securing every 8" into each stud.



Catskill Building Kit

## Front Wall Assembly



Obtain component DH and place over door assembly. This can be fastened with 3" nails into frame. Continue using 3" nails approx. every 12" from outside door frame into the studs around the circumference of the door assembly.



Install temporary door braces over the door seam to secure door opening until wall is erected.

STEP

# 7

## Installing Walls and Trusses

The assembly of the wall and trusses will begin at the front wall, which will be braced and then end walls, with the rear wall being erected last. It is very important that panels line up, siding fits snug and walls remain square and level during the assembly process as any deviation will result in difficulties as you proceed through the subsequent steps. At each step, always fasten one or two nails and double check for alignment and squareness to ensure a proper fit before completing the nailing. The wall panels you have assembled are very heavy and require at least three individuals to carefully erect. These should not be assembled in breezy weather.

### Front Wall Installation



With the help of your assistants, obtain front wall just assembled and carefully lift to an upright position, positioning base at front edge of floor assembly.

# Front Wall Installation

**B** The wall assembly should be centered on the floor and the siding should overhang the front edge of the floor assembly while the plate sits directly on the floor surface. When positioned properly, and have two individuals continue to support the wall, another assistant can nail through siding into floor every 8".



**C** Obtain the 8' braces included and fasten temporarily to the inside of the studs at the upper portion at each end of the front wall. While your assistants support the wall, square the wall using a level, fasten the lower portion of the brace to the floor by toe-nailing into floor surface.



**D** Double check that the front wall is square and level and repeat for second brace.

Nail bottom plate into floor every 12" with 3" nails.



Catskill Building Kit

## End Wall Installation



- A** With help from your assistant lift one of the end wall assemblies into position with the center brace sitting on the floor and the siding overlapping the floor edge and sitting on the temporary braces installed in Step 2.



- B** Ensure that wall is level and centered horizontally on floor. The siding surface should overhang floor or sill plates by  $1\frac{1}{2}$ " and the siding edge should line up with the front wall just installed. If this does not line up, either the front wall is not square with the floor or the floor surface is not level. This must be corrected before assembly proceeds further.

While your assistant holds the wall, fasten first to the front wall end stud and then along bottom, ensuring squareness. Once corners are tacked, and squareness and alignment are checked the panel should be nailed every 8" along bottom into floor and along edge into front wall end stud.



- C** Repeat for remaining end wall assembly again ensuring that the end wall aligns properly with the front wall at the seam before securing wall panel.

# Rear Wall Installation

**A** The rear wall will require at least three individuals to erect.

Carefully lift rear wall assembly to an upright position and place plate on edge of floor assembly leaving the siding to overhang the floor edge.



**B** Ensure the end wall panels align properly on each side and tack each top corner from end wall into rear wall end studs.

Once alignment and squareness is checked, nail every 8" from end walls into rear wall studs and firm rear wall siding into floor assembly.



**C** Remove temporary door braces to gain access to interior of building and nail plate to floor along rear wall every 12" with 3" nails.

The temporary front wall braces can now be removed.



Catskill Building Kit

## Main Truss Installation



- A** Carefully working from a ladder, mark the top plate for truss placement.

Marking from the left side of the building (door side measuring from outside of siding), mark every 24". If you mark 24" directly from the end wall, remember that your truss will sit just to the right of the end wall, and therefore each truss will sit just to the right of your 24" mark.

Repeat for rear, again working from the same end wall.



- B** Working from a ladder with help from an assistant, obtain one of the main trusses assembled in step 3 that was assembled using one gusset plate.

Starting from the left, position against the end wall such that the gusset plate faces the interior of the building and the truss fits flush against the end wall. Toenail the truss into the top plate of the front and rear wall.

Fasten from side wall panel into truss at front and rear. Repeat for the truss to be positioned at the far right, first toenailing into top plate and then along top of end wall siding into truss.



- C** All your remaining trusses should have gusset plates on both sides of the truss assembly. Position and fasten the remaining trusses to the top plates at the front and rear, ensuring proper spacing. The spacing at the peak of the truss can be adjusted when the roof sheathing is installed.

# Roof Sheathing Installation

STEP

8

- A** Working from a secure ladder, and with help from your assistants, position the larger 8' sheathing panel (J2) at the far left of the front side of the roof. Your assistant may wish to work from a ladder on the inside of the building

*Do not climb on the roof at this point, as the strength of the roof is insufficient until the sheathing is completely installed.*

Align sheathing with top of roof trusses and with the left end wall. This should allow the right edge of the panel to line up with your 5th truss assembled in the previous step.

- B** Tack a nail on the corners of the sheathing into the trusses. Obtain the larger 71<sup>3</sup>/<sub>4</sub>" sheathing panel (K2) and position it along the peak, such that it aligns with the right end wall and secure with nails at the corners.



Catskill Building Kit

# Roof Sheathing Installation



**C** Again starting from the left, using the narrower 8' sheathing strip (J1), align against previously installed panel and fasten at the corners.

Repeat for the right side (K1). Align the peak of the trusses at 24" intervals and tack a nail to secure the alignment.

Once the sheathing and trusses are squared, the sheathing can be nailed every 8" into each truss with 1 3/4" nails. The sheathing may have ink guidelines, or you can mark trusses and use a chalk line to draw a nailing guide.

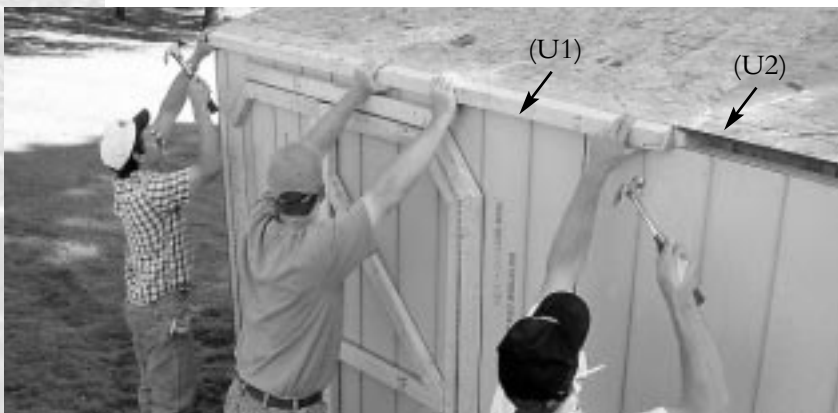

**D** The front and back eave trim (U1, U2) will be installed next. They have an angle cut on one end only. The angle should face upward. It should fit flush against front and rear wall siding. Again secure with 1 3/4" nails.



**E** The gable over the door can now be installed.

Obtain the forward facing gable end (G1) and position it on the front eave trim centered over the door. This can be toenailed into trim/sheathing and trusses but should be supported by your assistant until braced.



**F** Obtain the gable brace (G2) and fasten to the peak of the gable end with a 3" nail.

From a ladder on the inside of the building fasten the other end of the brace to the roof at a position that brings the gable end to a square position.

Your assistant at the front of the building can use a level on the gable end to indicate the proper positioning.

# Roof Sheathing Installation

- F** The gable sheathing (L1) can now be installed by fastening to the existing roof sheathing and the gable brace. Again, fasten every 8" to secure sheathing.
- G** The sheathing on the rear of the building can now be installed. Installation should begin on the left side of the building (the door side) and move towards the right side. Begin with the full sheet (J2) and follow with the 71<sup>3</sup>/<sub>4</sub>" (K2) sheet. Then the 96" strip (J1) and 71<sup>3</sup>/<sub>4</sub>" strip (K1) can be installed. Ensure alignment before nailing every 8" into each truss.



## Trim / Hardware Installation

STEP

9

- A** The trim consists of 2" x 3" front and rear eave extension trim already installed in Step 8 (letter D), 1" x 4" corner trim and 1" x 3" end wall eave trim.

The end wall eave trim (Q1) will be installed first and will have cut angles on both ends. It should cover the edge of the roof sheathing and align at the peak, and the ends should be flush with front and rear wall siding. Secure with 1<sup>3</sup>/<sub>4</sub>" nails. Repeat for 4 roof corners.

- B** The end wall corner trim (R1) will be installed next. It has an angle cut on one end only. The angle should face upward underneath the roof trim installed above. It should fit flush against front and rear wall siding. Again secure with 1<sup>1</sup>/<sub>4</sub>" nails.

Repeat for four wall corners.

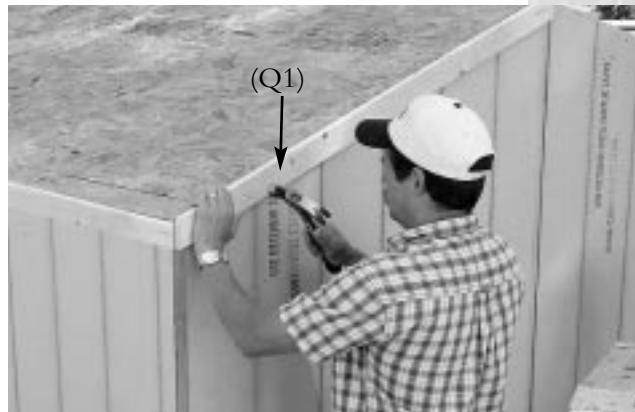

Catskill Building Kit

# Trim/Hardware Installation



**D** Finally the 1" x 4" front and rear wall corner trim (S1) can be installed. It is square on both ends, and should fit snugly underneath the eave trim just installed. It should also cover the edges of the end wall corner trim and create a flush square corner finish. Secure with 1<sup>3</sup>/<sub>4</sub>" nails and repeat for the four corners.

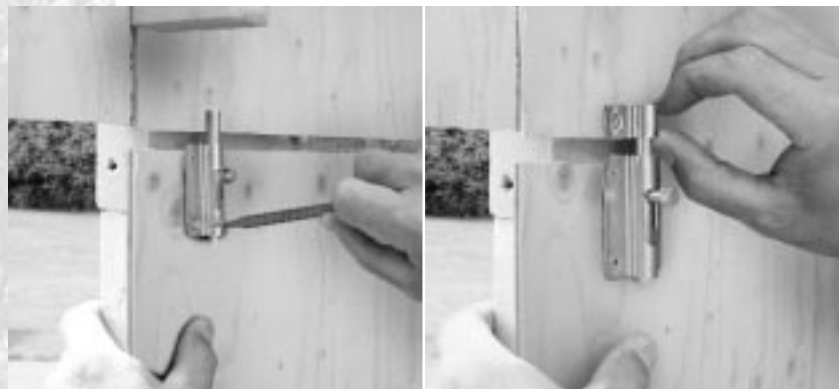

**E** Obtain vertical weather-strip and position on inside of left door, leaving approx. 1" to overlap the existing door edge. This will close the gap between the two doors when they are closed. Fasten with 1<sup>3</sup>/<sub>4</sub>" screws every 16"  
(no picture available)



**F** From the inside of the barn, install the loop and barrel bolt to the left door. The barrel bolt should be secured to the inside peak of the door, While the loop should be installed inside underneath the door header. Check alignment before fastening.

**G** Cut bottom Plate

**H** The outside door latch should be installed on the outside of the right door, with the latch loop being aligned on the left door.

# Installing Shingles and Paint

STEP

9

Your Catskill Outdoor Building now requires the finishing touches to be complete. You should require 8 bundles of shingles to complete the roof. Install as per manufacturer's instructions. It is recommended that a minimum 1/2" overhang is retained on each edge of the roof to ensure proper drainage.



Before painting, all seams in the siding and trim must be caulked for a proper seal. The siding of your building is pre-primed and is ready to accept an exterior grade oil or latex based paint. Any trim or bare wood should be treated with a primer coat before final paint is applied. Two coats of final paint should be applied. Your siding will require a full gallon of paint, while 1 or 2 quarts should be sufficient to complete the trim.

# Congratulations



Your Backyard  ORGANIZER by *Suntrellis* is Now Complete!

Catskill Building Kit

## Quality Options and Accessories



### *Floor Kits*

Available to custom fit each of The Backyard Organizer building sizes. Floor kits consist of 2" x 4" treated select SPF lumber, and 5/8" plywood flooring.

### *Shelf Kits*

12" x 48" shelf kits attach easily to the interior of any Backyard Organizer building providing convenient additional storage solutions.

### *Ramp Kits*

Treated ramp kits allow easy access to any Backyard Organizer building.

### *Shutter Kits and Flower Box Kits*

Provide decorative finishing touch to any of The Backyard Organizer buildings window kits.

### *Windows*

Fit any of The Backyard Organizer building styles (except the Acadia), windows are available in either a double hung format with a screen or as fixed decorative window. Window kits come with all necessary materials to install your window.

### *Packaging*

Each Backyard Organizer comes pre-wrapped with a water proof polytarp cover for easy transport and storage.



## *Store it in Style*

[www.backyard-organizer.com](http://www.backyard-organizer.com)